

JVC

COMPACT VHS CAMCORDER

GR-AXM237UM

Compact VHS

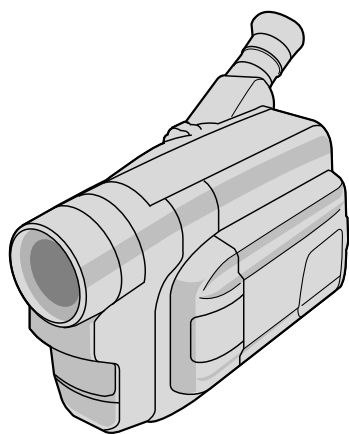

INSTRUCTIONS

ENGLISH

CONTENTS

SAFETY PRECAUTIONS	2 - 5
QUICK OPERATION GUIDE	6
MAJOR FEATURES	7
PROVIDED ACCESSORIES	7
GETTING STARTED	8 - 13
RECORDING	14 - 27
Basic Recording	14
Basic Features	16
Advanced Features	18
PLAYBACK	28 - 32
Basic Playback	28
Features	29
Connections	30
Using The Cassette Adapter	32
USER MAINTENANCE	33
TROUBLESHOOTING	34 - 35
INDEX	36 - 39
Controls, Connectors And Indicators	36
Indications	38
CAUTIONS	40 - 41
TERMS	42
SPECIFICATIONS	43

Dear Customer,

Thank you for purchasing the JVC Compact VHS camcorder. Before use, please read the safety information and precautions contained in the following pages to ensure safe use of this product.

Using This Instruction Manual

- All major sections and subsections are listed in the Table Of Contents on the cover.
- Notes appear after most subsections. Be sure to read these as well.
- Basic and advanced features/operation are separated for easier reference.

It is recommended that you . . .

- refer to the Index (☞ pgs. 36 – 39) and familiarize yourself with button locations, etc. before use.
- read thoroughly the Safety Precautions and Safety Instructions that follow. They contain extremely important information regarding the safe use of this product.

You are recommended to carefully read the cautions on pages 40 – 41 before use.

SAFETY PRECAUTIONS

WARNING:

TO PREVENT FIRE OR SHOCK HAZARD, DO NOT EXPOSE THIS UNIT TO RAIN OR MOISTURE.

Caution on Replaceable lithium battery

The battery used in this device may present a fire or chemical burn hazard if mistreated. Do not recharge, disassemble, heat above 100°C or incinerate.

Replace battery with Panasonic (Matsushita Electric), Sanyo, Sony or Maxell CR2025.

Danger of explosion or Risk of fire if the battery is incorrectly replaced.

- Dispose of used battery promptly.
- Keep away from children.
- Do not disassemble and do not dispose of in fire.

CAUTIONS:

- To prevent shock, do not open the cabinet. No user serviceable parts inside. Refer servicing to qualified personnel.
- When you are not using the AC Power Adapter/Battery charger for a long period of time, it is recommended that you disconnect the power cord from AC outlet.

NOTES:

- The rating plate (serial number plate) and safety caution are on the bottom and/or the back of the main unit.
- The rating information and safety caution of the AC Power Adapter/Charger are on its bottom.

This camcorder is designed to be used with NTSC-type color television signals. It cannot be used for playback with a television of a different standard. However, live recording and LCD monitor/viewfinder playback are possible anywhere. Use the BN-V11U/V12U/V20U battery packs and, to recharge them, the provided multi-voltage AC Power Adapter/Charger. (An appropriate conversion adapter may be necessary to accommodate different designs of AC outlets in different countries.)

ATTENTION:

The product that you have purchased is powered by a rechargeable battery. The battery is recyclable. At the end of its useful life, under various state and local laws, it may be illegal to dispose of this battery into the municipal waste stream. Check with your local solid waste officials for details in your area for recycling options or proper disposal.

When the equipment is installed in a cabinet or on a shelf, make sure that it has sufficient space on all sides to allow for ventilation (10 cm (3-15/16") or more on both sides, on top and at the rear).

Do not block the ventilation holes.

(If the ventilation holes are blocked by a newspaper, or cloth etc. the heat may not be able to get out.)

No naked flame sources, such as lighted candles, should be placed on the apparatus.

When discarding batteries, environmental problems must be considered and the local rules or laws governing the disposal of these batteries must be followed strictly.

The apparatus shall not be exposed to dripping or splashing.

Do not use this equipment in a bathroom or places with water.

Also do not place any containers filled with water or liquids (such as cosmetics or medicines, flower vases, potted plants, cups etc.) on top of this unit.

(If water or liquid is allowed to enter this equipment, fire or electric shock may be caused.)

IMPORTANT PRODUCT SAFETY INSTRUCTIONS

Electrical energy can perform many useful functions. But improper use can result in potential electrical shock or fire hazards. This product has been engineered and manufactured to assure your personal safety. In order not to defeat the built-in safeguards, observe the following basic rules for its installation, use and servicing.

ATTENTION:

Follow and obey all warnings and instructions marked on your product and its operating instructions. For your safety, please read all the safety and operating instructions before you operate this product and keep this manual for future reference.

INSTALLATION

1. Power Sources

Operate your product only from the type of power source indicated on the marking label. If you are not sure of the type of power supply to your home, consult your product dealer or local power company. If your product is intended to operate from battery power, or other sources, refer to the operating instructions.

2. Overloading

Do not overload wall outlets, extension cords, or integral convenience receptacles as this can result in a risk of fire or electric shock.

3. Power Cord Protection

Power supply cords should be routed so that they are not likely to be walked on or pinched by items placed upon or against them, paying particular attention to cords at plugs, convenience receptacles, and the point where they exit from the product.

4. Ventilation

Slots and openings in the cabinet are provided for ventilation. To ensure reliable operation of the product and to protect it from overheating, these openings must not be blocked or covered.

- Do not block the openings by placing the product on a bed, sofa, rug or other similar surface.
- Do not place the product in a built-in installation such as a bookcase or rack unless proper ventilation is provided or the manufacturer's instructions have been adhered to.

5. Wall or Ceiling Mounting

The product should be mounted to a wall or ceiling only as recommended by the manufacturer.

ANTENNA INSTALLATION INSTRUCTIONS

1. Outdoor Antenna Grounding

If an outside antenna or cable system is connected to the product, be sure the antenna or cable system is grounded so as to provide some protection against voltage surges and built-up static charges. Article 810 of the National Electrical Code, ANSI/NFPA 70, provides information with regard to proper grounding of the mast and supporting structure, grounding of the lead-in wire to an antenna discharge unit, size of grounding conductors, location of antenna discharge unit, connection to grounding electrodes, and requirements for the grounding electrode.

2. Lightning

For added protection for this product during a lightning storm, or when it is left unattended and unused for long periods of time, unplug it from the wall outlet and disconnect the antenna or cable system. This will prevent damage to the product due to lightning and power-line surges.

3. Power Lines

An outside antenna system should not be located in the vicinity of overhead power lines or other electric light or power circuits, or where it can fall into such power lines or circuits. When installing an outside antenna system, extreme care should be taken to keep from touching such power lines or circuits as contact with them might be fatal.

EXAMPLE OF ANTENNA GROUNDING AS PER NATIONAL ELECTRICAL CODE, ANSI/NFPA 70

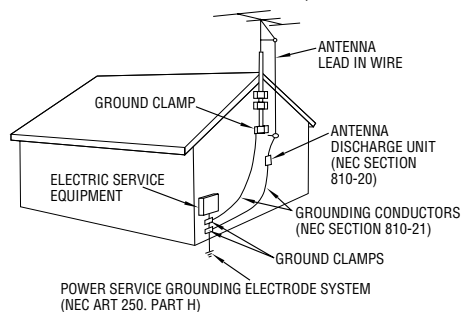

NEC - NATIONAL ELECTRICAL CODE

USE

1. Accessories

To avoid personal injury:

- Do not place this product on an unstable cart, stand, tripod, bracket or table. It may fall, causing serious injury to a child or adult, and serious damage to the product.
- Use only with a cart, stand, tripod, bracket, or table recommended by the manufacturer or sold with the product.
- Use a mounting accessory recommended by the manufacturer and follow the manufacturer's instructions for any mounting of the product.
- Do not try to roll a cart with small casters across thresholds or deep-pile carpets.

2. Product and Cart Combination

A product and cart combination should be moved with care. Quick stops, excessive force, and uneven surfaces may cause the product and cart combination to overturn.

PORTABLE CART WARNING
(Symbol provided by RETAC)



3. Water and Moisture

Do not use this product near water—for example, near a bath tub, wash bowl, kitchen sink or laundry tub, in a wet basement, or near a swimming pool and the like.

4. Object and Liquid Entry

Never push objects of any kind into this product through openings as they may touch dangerous voltage points or short-out parts that could result in a fire or electric shock. Never spill liquid of any kind on the product.

5. Attachments

Do not use attachments not recommended by the manufacturer of this product as they may cause hazards.

6. Cleaning

Unplug this product from the wall outlet before cleaning. Do not use liquid cleaners or aerosol cleaners. Use a damp cloth for cleaning.

7. Heat

The product should be situated away from heat sources such as radiators, heat registers, stoves, or other products (including amplifiers) that produce heat.

SERVICING

1. Servicing

If your product is not operating correctly or exhibits a marked change in performance and you are unable to restore normal operation by following the detailed procedure in its operating instructions, do not attempt to service it yourself as opening or removing covers may expose you to dangerous voltage or other hazards. Refer all servicing to qualified service personnel.

2. Damage Requiring Service

Unplug this product from the wall outlet and refer servicing to qualified service personnel under the following conditions:

- When the power supply cord or plug is damaged.
- If liquid has been spilled, or objects have fallen into the product.
- If the product has been exposed to rain or water.
- If the product does not operate normally by following the operating instructions. Adjust only those controls that are covered by the operating instructions as an improper adjustment of other controls may result in damage and will often require extensive work by a qualified technician to restore the product to its normal operation.
- If the product has been dropped or damaged in any way.
- When the product exhibits a distinct change in performance—this indicates a need for service.

3. Replacement Parts

When replacement parts are required, be sure the service technician has used replacement parts specified by the manufacturer or have the same characteristics as the original part. Unauthorized substitutions may result in fire, electric shock or other hazards.

4. Safety Check

Upon completion of any service or repairs to this product, ask the service technician to perform safety checks to determine that the product is in safe operating condition.

SUPPLY POWER

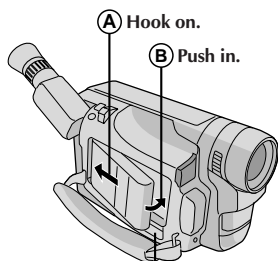

BATTERY RELEASE

Using the battery pack

Hook its end to the camcorder (A) and push the battery pack in until it locks in place (B).
(Charging procedure, pg. 8)

To remove the battery pack

Slide **BATTERY RELEASE** and pull out the battery pack.

INSERTING A VIDEO CASSETTE

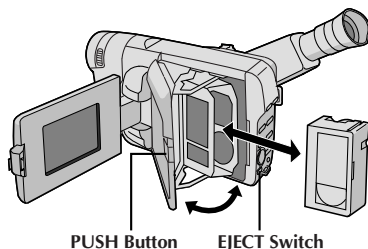

- 1 Open the LCD monitor fully.
- 2 Slide **EJECT** to open the cassette holder.
- 3 Insert a video cassette.
- 4 Press **PUSH** to close the cassette holder.
(For more details, pg. 10)

PLAYBACK

2 Rewind (◀) Button

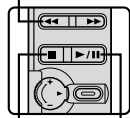

3 Play/Pause (▶/||) Button

Stop (■) Button

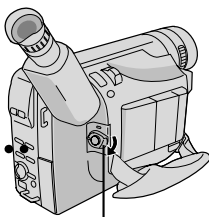

1 Set to "PLAY".

- 1 Set the Power Switch to "PLAY".
- 2 Press **◀**.
— The tape will automatically stop at the beginning of the tape.
- 3 Press **▶/||**.
— Playback starts and the playback picture appears.

• To stop playback, press **■**.
(For more details, pg. 28.)

- The viewfinder switches off automatically to save power when the LCD monitor is opened at an angle of over 60 degrees.
- The LCD monitor turns on/off when it is opened/closed at approx. 60 degrees.

Or simply play back the tape on a VHS VCR using the Cassette Adapter (VHS Playpak).
 pg. 32

SHOOTING

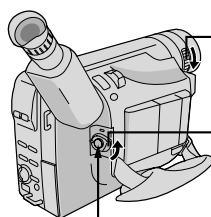

1 LENS COVER Open/Close Ring

2 Set to "AUTO" or "PRO.".

3 Recording Start/Stop Button

- 1 Turn the **LENS COVER** Open/Close Ring to open the lens cover.
 - 2 Set the Power Switch to "AUTO" or "PRO.". — The power lamp will light and an image will appear.
 - 3 Press the Recording Start/Stop Button. — Recording starts.
- To stop recording temporarily, momentarily press the Recording Start/Stop Button once again.
(For more details, pgs. 14, 15)

- The viewfinder switches off automatically to save power when the LCD monitor is opened at an angle of over 60 degrees.
- The LCD monitor turns on/off when it is opened/closed at approx. 60 degrees.

Program AE with Special Effects (☞ pg. 19)

- Electronic Fog Filter ■ ND Effect
- Sepia ■ Twilight ■ Sports ■ Nega/Posi
- 1/2000 sec. High Speed Shutter

TBC (Time Base Corrector) (☞ pg. 29)

Picture Stabilizer (☞ pg. 16)

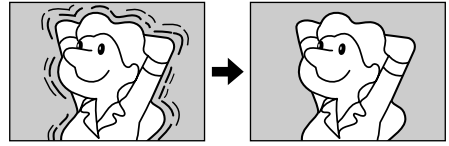

Digital Hyper Zoom (☞ pg. 16)

PROVIDED ACCESSORIES



• AC Power Adapter/Charger AA-V16U

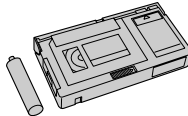

• Cassette Adapter (VHS Playpak) C-P7U

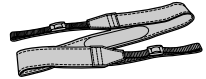

• Shoulder Strap



• Battery Pack BN-V11U



• Lithium Battery CR2025 (for clock operation)

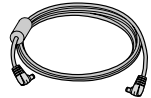

• DC Cord

NOTES about Automatic Demonstration

Automatic Demonstration takes place when "DEMO MODE" is set to "ON" (factory-preset).

- Available when the Power Switch is set to "AUTO" or "PRO."
- Operating the Power Zoom Lever during the demonstration stops the demonstration temporarily. If the Power Zoom Lever is not moved for more than 1 minute after that, the demonstration will resume.
- To cancel Automatic Demonstration, set the Power Switch to "PRO." and press **MENU** while the demo is in progress. This takes you directly to the demo mode's Setting Menu (so you will not have to go through the main Menu Screen.) Rotate the Select Wheel to select "OFF" and press it.



Setting Menu

* "DEMO MODE" remains "ON" even if the camcorder power is turned off.

NOTE:

When a tape whose Erase Protection tab is in the position that allows recording is loaded in the camcorder, demonstration is not available.



Cassettes marked **VHS** can be used with this camcorder.

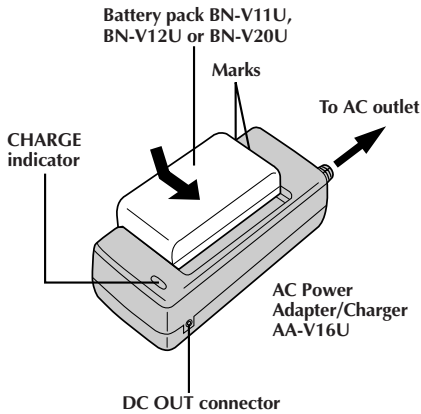

Battery pack	Charging time
BN-V11U	approx. 1 hr. 10 min.
BN-V12U (optional)	approx. 1 hr. 10 min.
BN-V20U (optional)	approx. 1 hr. 50 min.

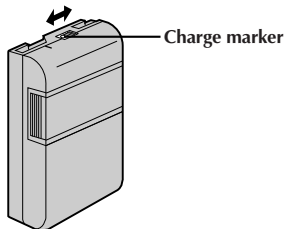

ATTENTION:

Charging a battery with some charge remaining reduces that battery's capacity. Perform the procedure below to fully discharge the battery pack before recharging.

1. Attach the battery pack to the camcorder and make sure a cassette is **not** inserted, then set the Power Switch to "AUTO" or "PRO."
2. The camcorder power turns off automatically when discharging is complete.

When you are not using a battery pack for a long period of time, be sure to fully discharge it before storing because leaving a battery with some charge left over also reduces performance.

Power

This camcorder's 3-way power supply system lets you choose the most appropriate source of power. Do not use provided power supply units with other equipment.

CHARGING THE BATTERY PACK

- 1 Make sure you unplug the camcorder's DC cord from the AC Power Adapter/Charger. Plug the AC Adapter/Charger's power cord into an AC outlet.
- 2 Align the marks and slide the battery pack in the direction of the arrow until it locks in place. The CHARGE indicator begins blinking to indicate charging has started.
- 3 When the CHARGE indicator stops blinking but stays lit, charging is finished. Slide the battery in the opposite direction of the arrow and lift off. Remember to unplug the AC Adapter/Charger's power cord from the AC outlet.

Charge Marker

A charge marker is provided on the battery pack to help you remember whether it has been charged or not. Two colors are provided (red and black)—you choose which one means charged and which means discharged.

NOTES:

- Perform charging where the temperature is between 10° and 35°C (50°F and 95°F). 20° to 25°C (68°F to 77°F) is the ideal temperature range for charging. If the environment is too cold, charging may be incomplete.
- Charging times noted above are for a fully discharged battery pack.
- Charging time varies according to the ambient temperature and the status of the battery pack.
- To avoid interference with reception, do not use the AC Power Adapter/Charger near a radio.
- If you connect the camcorder's DC cord to the adapter during battery charging, power is supplied to the camcorder and charging stops.
- Since the AC Power Adapter/Charger processes electricity internally, it becomes warm during use. Be sure to use it only in well-ventilated areas.
- When charging the battery pack for the first time or after a long storage period, the CHARGE indicator may not light. In this case, remove the battery pack from the AC Power Adapter/Charger, then try charging again.
- If the battery operation time remains extremely short even after having been fully charged, the battery is worn out and needs to be replaced. Please purchase a new one.
- Remember to set the charge marker after charging a battery pack or after detaching a discharged one from your camcorder.

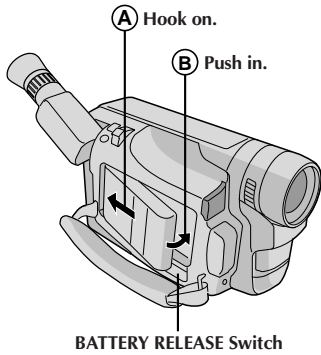

BATTERY RELEASE Switch

ATTENTION:

Before detaching the power source, make sure that the camcorder's power is turned off. Failure to do so can result in a camcorder malfunction.

INFORMATION:

VU-V856KIT is a set composed of the BN-V856U battery pack and AA-V80U AC Power Adapter/Charger.

Read the VU-V856KIT's instruction manuals before using.

It is impossible to charge the BN-V856U battery pack using the provided AC Power Adapter/Charger. Use the optional AA-V80U AC Power Adapter/Charger.

USING THE BATTERY PACK

Hook its end to the camcorder (A) and push the battery pack in until it locks in place (B).

- If the battery pack is attached in the wrong position, a malfunction may occur.

To Detach The Battery Pack . . .

.... slide **BATTERY RELEASE** and pull out the battery pack.

Approximate recording time

Battery pack	LCD monitor off/ Viewfinder on	LCD monitor on/ Viewfinder off	LCD monitor on/ Viewfinder on
BN-V11U	1 hr. 30 min.	1 hr. 20 min.	1 hr. 10 min.
BN-V12U (optional)	1 hr. 30 min.	1 hr. 20 min.	1 hr. 10 min.
BN-V20U (optional)	2 hrs. 20 min.	2 hrs. 10 min.	1 hr. 55 min.
BN-V856U (optional)	9 hrs. 30 min.	8 hrs. 40 min.	7 hrs. 40 min.

NOTES:

- Recording time is reduced significantly under the following conditions:
 - Zoom or Record-Standby mode is engaged repeatedly.
 - The LCD monitor is used repeatedly.
- Before extended use, it is recommended that you prepare enough battery packs to cover 3 times the planned shooting time.

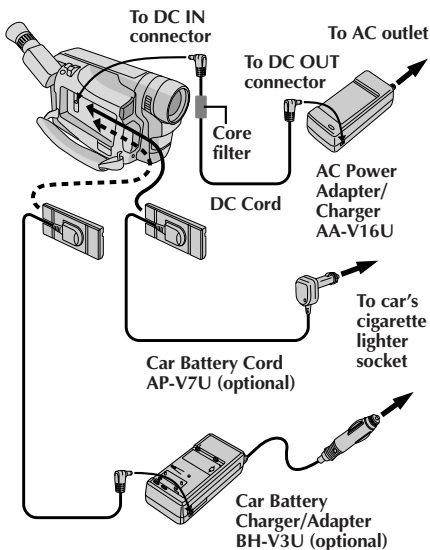
**USING AC POWER**

Use the AC Power Adapter/Charger (connect as shown in the illustration).

NOTES:

- The provided AC Power Adapter/Charger features automatic voltage selection in the AC range from 110 V to 240 V.
- For other notes, see pg. 8.

USING A CAR BATTERY

Use the optional Car Battery Cord or Car Battery Charger/Adapter (connect as shown in the illustration).

NOTES:

- When using the car battery, leave the engine idling.
- The optional Car Battery Charger (BH-V3U) can also be used to charge the battery pack (except BN-V20U/V856U).
- When using the optional Car Battery Charger or Car Battery Cord (AP-V7U), refer to the respective instruction booklet.

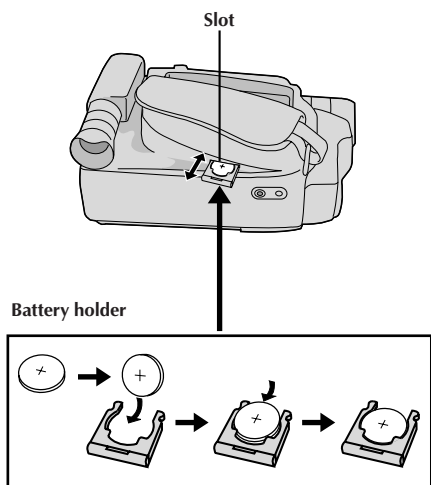

Clock (Lithium) Battery Insertion/Removal

This battery is necessary for clock operation and to perform date/time settings.

- 1** Switch off the unit's power and remove the power supply unit (battery pack, AC Power Adapter/Battery Charger, etc.).
- 2** Pull out the battery holder to remove it from the camcorder.
- 3** Insert the battery in the holder, and be sure to have the "+" mark visible.
- 4** Slide the holder back into the slot until you hear a click.

NOTES:

- See "SAFETY PRECAUTIONS" (☞ pg. 2) for information on safe handling of lithium batteries.
- To avoid losing the battery and/or battery holder, place the camcorder with the grip side up as shown in the illustration when inserting/removing the battery.

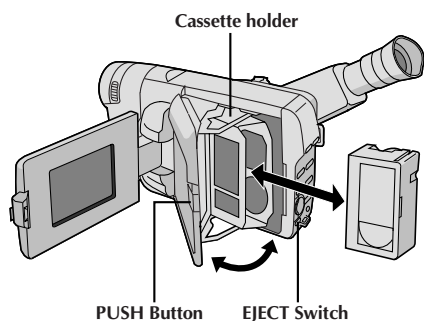

Loading/Unloading A Cassette

- 1** Open the LCD monitor fully.
- 2** Slide **EJECT** until the cassette holder opens. Do not use force to open.
- 3** Insert or remove a cassette. When inserting, make sure the label is facing outward.
- 4** Press **PUSH** to close the cassette holder until it locks into place. Close the LCD monitor.

NOTES:

- Closing the LCD monitor while the cassette holder is still open may cause damage to the LCD monitor.
- The cassette holder can't be opened unless a power supply is attached.
- Make sure that the tape is not slack when loading the cassette. If there is any slack, turn the gear on the cassette in the direction of the arrow to take up the slack.
- Make sure the Erase Protection tab is in the position that allows recording. If not, slide the tab. Some cassettes have removable tabs. If the tab has been removed, cover the hole with adhesive tape.
- The cassette holder cannot be opened while the camcorder is in the record mode.

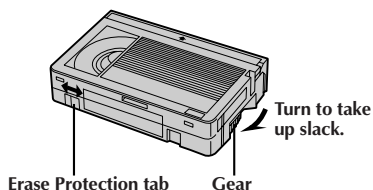

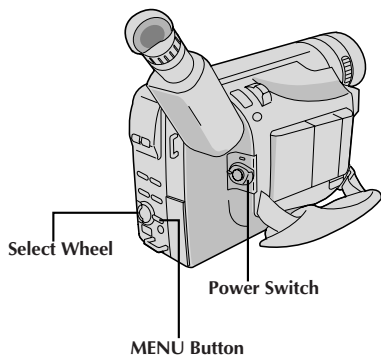

Display



Menu Screen 1

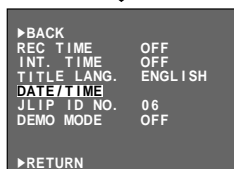

Menu Screen 2

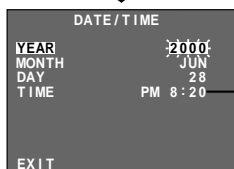

DATE/TIME Menu

12-hour indication
with AM or PM

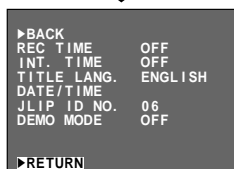

Date/Time Settings

- 1 Set the Power Switch to "PRO.". The power lamp comes on.
- 2 Press MENU. The Menu Screen appears.
- 3 Rotate the Select Wheel to move the highlight bar to "NEXT" in Menu Screen 1 and press it to display Menu Screen 2. Then, rotate it to move the highlight bar to "DATE/TIME" and press it. The DATE/TIME Menu appears.
 - To return to the previous settings, rotate the Select Wheel to move the highlight bar to "EXIT" and press it, then go to step 7.
 - To set only the time without changing the date, go to step 5.
- 4 To set "YEAR", "MONTH" or "DAY", rotate the Select Wheel to move the highlight bar to the desired item, and press it. When the setting begins blinking, rotate the Select Wheel until the correct setting appears and then press it. The setting stops blinking. Repeat for other date settings.
- 5 Rotate the Select Wheel to move the highlight bar to "TIME" and then press it. When the hour setting begins blinking, rotate the Select Wheel until the correct setting appears and then press it. When the hour setting stops blinking and the minute setting begins blinking, rotate the Select Wheel until the correct setting appears and then press it. The minute setting stops blinking.
- 6 When none of these settings ("YEAR", "MONTH", "DAY", "TIME") blinks, rotate the Select Wheel to move the highlight bar to "EXIT", and press it. The Menu Screen reappears with the highlight bar on "RETURN".
- 7 Press the Select Wheel to close the Menu Screen.

NOTE:

To display the date and time in the camcorder's display and on a connected TV, see "Date/Time Insert" (pg. 23).

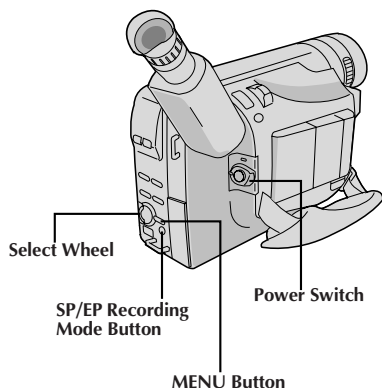

Recording Mode Setting

Set depending on your preference.

- 1 Set the Power Switch to "AUTO" or "PRO.". Press **SP/EP** for more than 1 second. "SP" (Standard Play) provides higher picture and sound quality and is better for dubbing, while "EP" (Extended Play) is more economical, providing three times the recording time.

NOTE:

If the recording mode is switched during recording, the playback picture will be blurred at the switching point.

Tape Length Setting

Set the tape length according to the length of the tape used.

- 1 Set the Power Switch to "PRO.", then press **MENU**.
- 2 Rotate the Select Wheel to move the highlight bar to "TAPE LENGTH", then press it. The TAPE LENGTH Setting Menu appears.
- 3 Rotate the Select Wheel to move the highlight bar to the correct tape length setting. T20=20 minutes of recording time, T30=30 minutes, T35=35 minutes, and T40=40 minutes (in SP).
 - To return to the previous setting, rotate the Select Wheel to move the highlight bar to "EXIT".
- 4 Press the Select Wheel. The Menu Screen reappears with the highlight bar on "RETURN". Press the Select Wheel again to close the Menu Screen.

NOTE:

The tape remaining time (⏪ pg. 14) displayed in the viewfinder is correct only if the correct tape length has been selected.

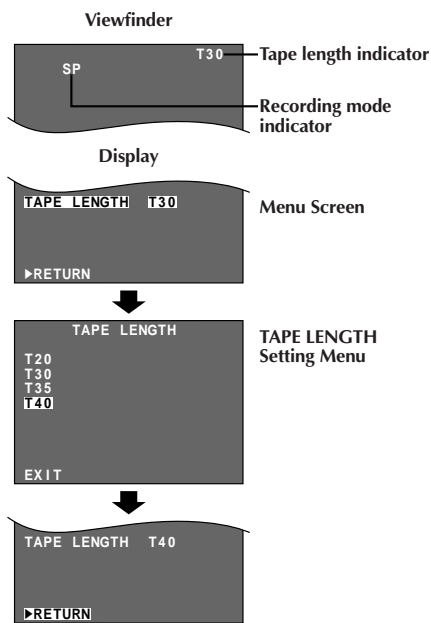

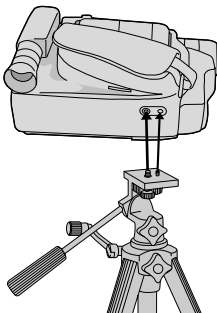
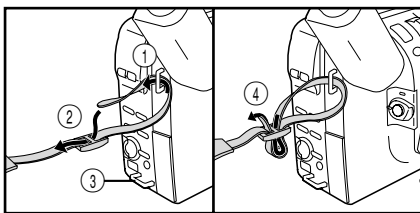
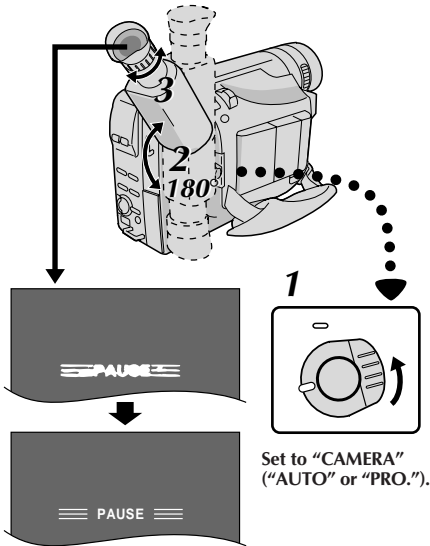
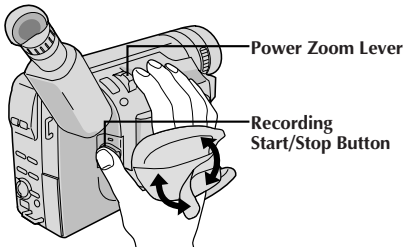

Grip Adjustment

- 1 Separate the Velcro strip.
- 2 Pass your right hand through the loop and grasp the grip.
- 3 Adjust so that your thumb and fingers can easily operate the Recording Start/Stop Button and Power Zoom Lever. Refasten the Velcro strip.

Viewfinder Adjustment

- 1 Set the Power Switch to "CAMERA" ("AUTO" or "PRO.").
- 2 Adjust the viewfinder manually for best viewability.
- 3 Turn the Diopter Adjustment Control until the indications in the viewfinder are clearly focused.

Shoulder Strap Attachment

- 1 Following the illustration, thread the strap through the eyelet ①, then fold it back and thread it through the buckle ②. Repeat the procedure to attach the other end of the strap to the other eyelet ③, making sure the strap is not twisted.
- 2 Adjust as shown in the illustration ④.

Tripod Mounting

- 1 Align the screw and camera direction stud on the tripod with the camera's mounting socket and stud hole. Then tighten the screw.

CAUTION:

When using a tripod, be sure to open and extend its legs fully to stabilize the camcorder. To prevent damage to the unit caused by falling over, do not use a small-sized tripod.

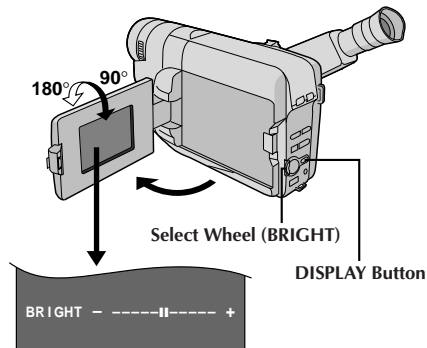
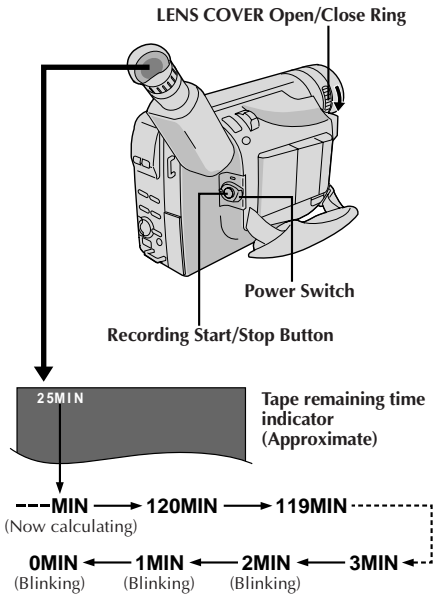

To Adjust The Brightness Of The LCD Monitor

.... rotate the Select Wheel (**BRIGHT**) until the bright level indicator on the display moves and the appropriate brightness is reached.

NOTE:

You should already have performed the procedures listed below. If not, do so before continuing.

- Power (☞ pg. 8)
- Recording Mode Setting (☞ pg. 12)
- Load A Cassette (☞ pg. 10)
- Grip Adjustment (☞ pg. 13)
- Viewfinder Adjustment (☞ pg. 13)

Shooting While Watching The Viewfinder

1 Make sure the LCD monitor is closed and locked. Turn the **LENS COVER** Open/Close Ring to open the lens cover. Set the Power Switch to "CAMERA" ("AUTO" or "PRO."). The power lamp lights and the camcorder enters the Record-Standby mode. "PAUSE" is displayed in the viewfinder.

2 Press the Recording Start/Stop Button. "REC" appears in the viewfinder while recording is in progress.

Shooting While Watching The LCD Monitor

1 Make sure the LCD monitor is fully open. Turn the **LENS COVER** Open/Close Ring to open the lens cover. Set the Power Switch to "CAMERA" ("AUTO" or "PRO."). The power lamp lights and the camcorder enters the Record-Standby mode. "PAUSE" is displayed in the LCD monitor.

2 Tilt the LCD monitor upward/downward for best viewability and press the Recording Start/Stop Button. "REC" appears in the LCD monitor while recording is in progress.

NOTE:

When you use the LCD monitor outdoors in direct sunlight, the LCD monitor may be difficult to see. If this happens, use the viewfinder instead.

To Stop Recording . . .

.... press the Recording Start/Stop Button. The camcorder re-enters the Record-Standby mode.

Power Switch Position

AUTO : Suitable for standard recording using NO special effects or manual adjustments.

PRO. : Allows you to set recording functions using the menus for more creative capabilities.

OFF : Switches off the camcorder.

PLAY : Allows you to play back your recordings.

NOTES:

- When the Power Switch is set to CAMERA and the LCD monitor is opened at an angle of 60 degrees or more, the LCD monitor switches on and the viewfinder switches off automatically to save power.
- The cassette holder cannot be opened unless a power supply is attached.
- There may be a delay after you slide **EJECT** until the cassette holder opens. Do not use force.
- The time required to calculate the remaining tape length, and the accuracy of the calculation, may vary according to the type of tape used.
- The tape remaining time indicator is correct only if the correct tape length has been selected (☞ pg. 12).
- "TAPE END" appears when the tape reaches its end, and the power goes off automatically if left in this condition for 5 minutes. "TAPE END" also appears when a cassette whose tape is already at its end is loaded.
- If the Record-Standby mode continues for 5 minutes without performing Zoom or any other operations, the camcorder's power shuts off automatically. Set the Power Switch to "OFF", and then back to "CAMERA" to turn the camcorder on again.
- If the Recording Start/Stop button is pressed after the Record-Standby mode has continued for over 5 minutes, recording may not start immediately.
- If you are recording on a cassette from the middle (such as when a tape is removed and re-inserted during recording), use the Retake function (☞ pg. 17) to find the end of the last recording so you do not erase any of it.
- While shooting, sound is not heard from the speaker.



Self-Recording

JOURNALISTIC SHOOTING

In some situations, different shooting angles may provide more dramatic results. Hold the camcorder in the desired position and tilt the LCD monitor in the most convenient direction. It can rotate 270° (90° downward, 180° upward).

INTERFACE SHOOTING

The person you shoot can view himself/herself in the LCD monitor, and you can even shoot yourself while viewing your own image in the LCD monitor.

Open the LCD monitor and tilt it upward to 180 degrees so that it faces forward. When the LCD monitor is tilted upward to an angle of over approx. 105 degrees, the monitor image is inverted vertically, and the viewfinder also switches on.

Point the lens toward the subject (yourself when self-recording) and start recording.

During Interface Shooting, the monitor image and indications do not appear inverted as they would when viewing a mirror.

NOTE:

The monitored image can be viewed on the LCD monitor and in the viewfinder.

LCD MONITOR/VIEWFINDER INDICATIONS

Press **DISPLAY** for more than 1 second to make the following indications appear/disappear from the camcorder's display: cassette warning, tape remaining time, battery pack remaining power indicator and tape length indicator (☞ pg. 38, 39).

NOTE:

Even if the indications are off, the tape remaining time appears blinking when the tape is near its end, and the battery pack remaining power indicator appears blinking when the power is almost gone.

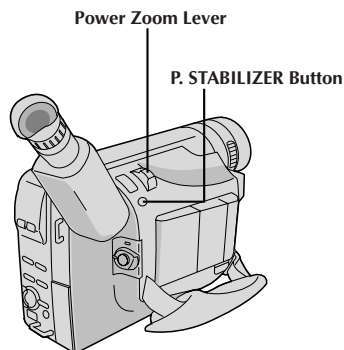
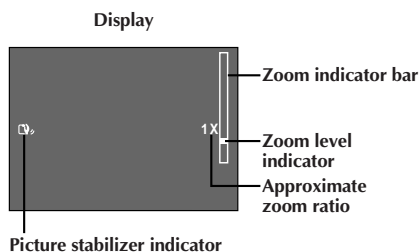
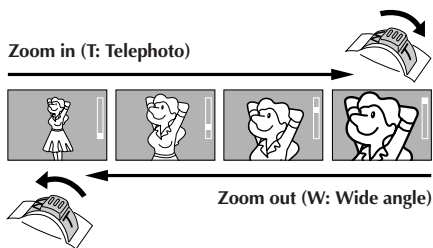

FEATURE: Zooming

PURPOSE:

To produce the zoom in/out effect, or an instantaneous change in image magnification. Digital circuitry extends the maximum magnification offered by optical zoom. This system is called Digital Zoom.

OPERATION:

Zoom In

Slide the Power Zoom Lever towards "T".

Zoom Out

Slide the Power Zoom Lever towards "W".

- The further you slide the Power Zoom Lever, the quicker the zoom action.

NOTES:

- Focusing may become unstable during Zooming. In this case, set the zoom while in Record-Standby, lock the focus by using the manual focus (☞ pg. 26), then zoom in or out in Record mode.
- The zoom level indicator (■) moves during zoom. Once the zoom level indicator reaches the top of the zoom indicator bar, all magnification from that point is through digital processing.
- When using Digital Zoom, the quality of image may suffer. To deactivate Digital Zoom, set "D.ZOOM" to "OFF" in the Menu Screen (☞ pg. 21).

FEATURE: Picture Stabilizer

PURPOSE:

To compensate for unstable images caused by camera-shake, particularly at high magnification.

OPERATION:

Press **P. STABILIZER**. "P" appears.

- To switch off the Picture Stabilizer, press **P. STABILIZER**. The indicator disappears.

NOTES:

- Accurate stabilization may not be possible if hand shake is excessive, or under the following conditions:
 - When shooting subjects with vertical or horizontal stripes.
 - When shooting dark or dim subjects.
 - When shooting subjects with excessive backlighting.
 - When shooting scenes with movement in various directions.
 - When shooting scenes with low-contrast backgrounds.
- Switch off the Picture Stabilizer when recording with the camcorder on a tripod.
- The "P" indicator appears blinking if the Stabilizer cannot be used.

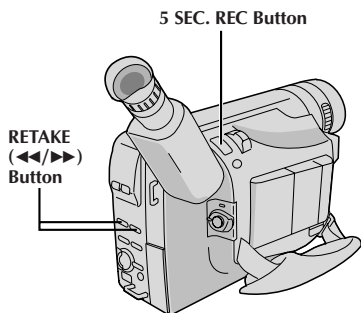

Display



5 Sec. Rec mode indicator

FEATURE: Quick Review

PURPOSE:

To check the end of the last recording.

OPERATION:

- 1) Set the Power Switch to "CAMERA" ("AUTO" or "PRO.").
- 2) Press << and release quickly during the Record-Standby mode.
 - Tape is rewound for approx. 2 seconds and played back automatically, then pauses in Record-Standby mode for the next shot.

NOTE:

Distortion may occur at the start of playback. This is normal.

FEATURE: Retake

PURPOSE:

To re-record certain segments.

OPERATION:

- 1) Make sure the camcorder is in the Record-Standby mode.
- 2) Press and hold either **RETAKE** to reach the start point for new recording. Pressing >> forwards the tape and pressing << reverses it.
- 3) Press the Recording Start/Stop Button to start recording.

NOTE:

Noise bars appear and pictures may become monochrome or darken during Retake. This is normal.

FEATURE: 5Sec. Rec (5-sec. Recording)

PURPOSE:

To record a scene for 5 seconds, providing quick scene transitions like those seen in TV programs.

OPERATION:

- Make sure the recording mode is set to "SP".
- 1) During Record-Standby, press **5SEC. REC.** "5S" appears and 5Sec. Rec is reserved.
 - 2) Press the Recording Start/Stop Button. Recording starts, and after 5-second recording is finished, the camcorder reenters the Record-Standby mode automatically.
 - To cancel the 5Sec. Rec. function, press **5SEC. REC** again so that "5S" disappears.

NOTE:

*Fade/Wipe (pg. 18) cannot be activated by pressing **5SEC. REC.***

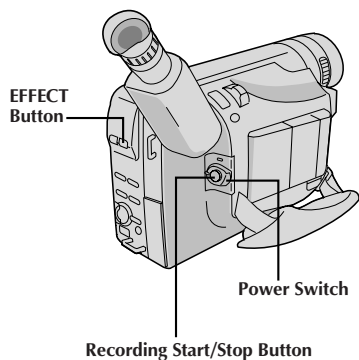

Fade/Wipe Effects

These effects let you make pro-style scene transitions. Fade- or wipe-in works at recording start, and fade- or wipe-out works at recording end or when you enter Record-Standby mode.

- 1** Set the Power Switch to "PRO."
- 2** Press **EFFECT** repeatedly until the desired mode's name and indication appear. They are displayed for approx. 2 seconds, then the name disappears so that only the indication remains. The effect is reserved.
- 3** Press the Recording Start/Stop Button to activate fade-in/out or wipe-in/out.
- 4** To cancel a fade or wipe, press **EFFECT** repeatedly until "OFF" appears. "OFF" is displayed for approx. 2 seconds and the fade/wipe standby mode is canceled.

NOTES:

- Pressing and holding the Recording Start/Stop Button allows you to vary the length for the image during fade in/out or wipe in/out.
- The screen becomes slightly reddish when the Fade/Wipe is used with Sepia (📖 pg. 19).

[Bk] FADER

Fades in/out to a black screen.

[Mosaic] MOSAIC (Fader)

Gradually turns/returns the picture into/from a mosaic pattern.

[Shutter] SHUTTER (Wipe)

A black screen moves in from the top and bottom, closing over the image like a shutter, or a new image pushes open the black screen vertically from the center.

[Slide] SLIDE (Wipe)

A black screen moves in from the left to gradually cover the image, or a new image moves in from right to left.

[Door] DOOR (Wipe)

Wipes in as the two halves of a black screen open to the left and right, revealing the scene, or wipes out and the black screen reappears from left and right to cover the scene.

[CW:Corner] CW:CORNER (Wipe)

Wipes in on a black screen from the upper right to the lower left corner, or wipes out from lower left to upper right, leaving a black screen.

[WW:Window] WW:WINDOW (Wipe)

The next scene gradually wipes in from the center of the screen toward the corners, covering the previous scene.

Program AE With Special Effects

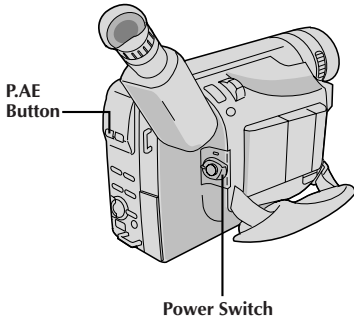

- 1** Set the Power Switch to "PRO."
- 2** Press **P.AE** repeatedly until the desired mode's name and indication appear. They are displayed for approx. 2 seconds, then the name disappears so that only the indication remains. The mode is activated.
- 3** To cancel the effect, press **P.AE** repeatedly until "OFF" appears. "OFF" is displayed for approx. 2 seconds.

NOTES:

- Only one mode can be engaged at a time.
- The screen becomes slightly reddish when the Fade/Wipe (☞ pg. 18) is used in the Sepia mode.
- The screen becomes slightly dark in the High Speed Shutter mode. Use in well-lit situations.
- In the "High Speed Shutter" or "Sports" modes, picture color may be adversely affected if the subject is lit by alternating discharge-type light sources such as fluorescent or mercury-vapor lights.

SEPIA

The scene being shot is recorded in sepia-tinted (reddish-brown) monochrome, giving the effect of an older movie. Use together with Wide (☞ pg. 21) for the authentic look of a classic Hollywood movie.

SPORTS

High shutter speed clearly captures fast-moving action.

ND:ND EFFECT

A black mist darkens the picture, as when an ND filter is used. Helps to counter the effects of glare on the subject.

FG:FOG

Makes the picture look misty white, as when an external fog filter is attached to the lens. Softens the image and gives it a "fantasy" look.

TWILIGHT

Dusk, twilight scenery, fireworks, etc., look more natural and dramatic. The following happens when Twilight mode is selected:

- Auto gain control is turned off.
- White Balance is set to "☀:FINE" (day mode), but can also be manually changed to another mode (☞ pg. 27).
- Auto Focus becomes available only in the range of 10 m (32 ft.) to infinity. To focus when the subject-to-camera distance is less than 10 m (32 ft.), use manual focusing (☞ pg. 26).

S1/2000 (1/2000 sec. High Speed Shutter)

Captures faster action than Sports mode.

NEGA POSI

The colors of a picture are reversed.

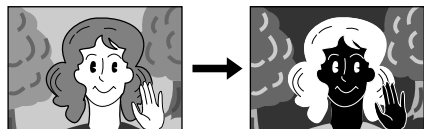

NEGA POSI mode

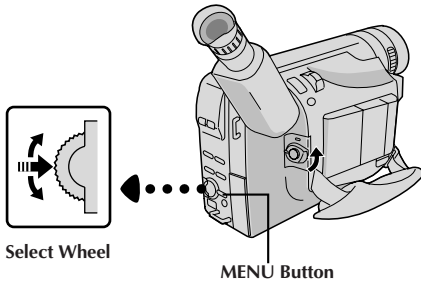

Select Wheel

MENU Button

Display
(ex. Menu Screen available using the MENU Button)

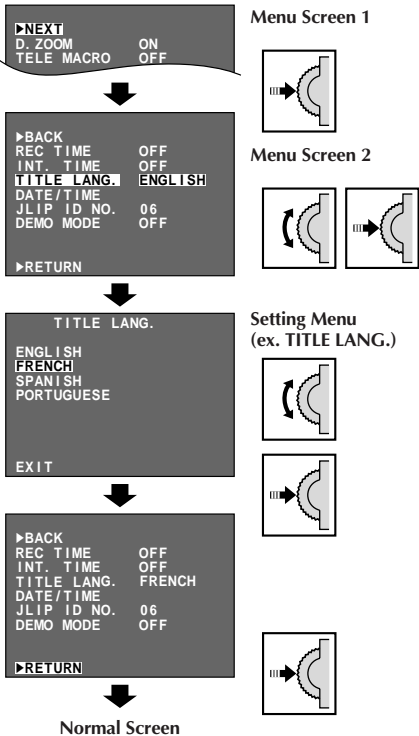

Using Menus For Detailed Adjustment

This camcorder is equipped with an easy-to-use, on-screen menu system that simplifies many of the more detailed camcorder settings.

- 1** Set the Power Switch to "PRO."
- 2** Menu access depends on the function you select.
 - If you select the functions from the "Menu Screen Available Using The Select Wheel" described on pg. 21 . . .*
 - press the Select Wheel. The Menu Screen appears.
 - If you select the functions from the "Menu Screen Available Using The MENU Button" described on pg. 21 and 22 . . .*
 - press MENU. The Menu Screen appears.
- 3** Rotate the Select Wheel to place the highlight bar on the desired function.
 - To go from Menu Screen 1 to Menu Screen 2, rotate the Select Wheel to "NEXT" and press it. To go back to Menu Screen 1 from Menu Screen 2, rotate the Select Wheel to "BACK", and press it.
 - To return to the previous setting, place the highlight bar on "RETURN", then go to step 6.
- 4** Press the Select Wheel. The setting procedure depends on the function you select.
 - If you select "FOCUS", "EXPOSURE", "M.W.B." or "DATE/ TIME" . . .*
 - see respective pages (FOCUS: pg. 26, EXPOSURE: pg. 24, M.W.B.: pg. 27, DATE/TIME: pg. 11) and perform each procedure from step 4.
 - If you select "JCLIP ID NO." . . .*
 - rotate the Select Wheel until the desired number appears, and press it. Then rotate the Select Wheel to move the highlight bar to "EXIT".
 - If you select any other functions . . .*
 - rotate the Select Wheel to move the highlight bar to the desired setting.
 - To return to the previous setting, place the highlight bar on "EXIT".
- 5** Press the Select Wheel. The Menu Screen reappears with the highlight bar on "RETURN".
- 6** Press the Select Wheel. The normal screen reappears.

NOTE:

No menu functions except "FOCUS" and "EXPOSURE" are available while in the Record mode.

MENU SCREEN EXPLANATIONS

Menu Screen Available Using The Select Wheel

FOCUS	Refer to "Focusing" (☞ pg. 26).	
EXPOSURE	Refer to "Exposure Control" (☞ pg. 24).	
M.W.B.	Refer to "White Balance Adjustment" and "Manual White Balance Operation" (☞ pg. 27).	
WIDE	OFF	Does not display black bars.
	ON	Allows you to record black bars at the top and bottom of the screen to produce a cinema-like "wide-screen" effect.
S.LX	MAX	To record a subject in a darkly lit environment, when it is more convenient to shoot the subject with a brighter image even if the picture becomes slightly coarse.
	NORMAL	To record a subject in a dimly lit environment, when it is more convenient to shoot with a less coarse picture although the subject becomes slightly dark. This setting is suitable for measuring sensitivity conforming to EIA-639 (EIA* Standard for Low Light Sensitivity Measurement). *EIA : Electronic Industries Alliance
	OFF	Allows you to shoot dark scenes with no picture brightness adjustment.
TITLE	Allows you to superimpose one of eight preset titles (☞ pg. 23).	
DATE/TIME DISP.	Makes the date/time settings appear in the camcorder or on a connected monitor (☞ pg. 23).	

Menu Screen Available Using The MENU Button

This Menu Screen cannot be accessed while recording.

D. ZOOM	ON	Allows you to use the Digital Zoom. By digitally processing and magnifying images, zooming is possible from 16X (the optical zoom limit), to a maximum of 450X digital magnification.
	OFF	Digital Zoom is not available. Only optical zoom (maximum 16x magnification) can function. When set to "OFF" during Digital Zoom, zoom magnification changes to 16X.
TELE MACRO	OFF	Usually the distance to a subject where the lens is in focus depends on the zoom magnification. Unless there is a distance of more than 1 m (3.25 ft.) to the subject, the lens is out of focus at the maximum telephoto setting. When set to "ON", you can shoot a subject as large as possible at a distance of approx. 60 cm (23-5/8"). • Depending on the zoom position, the lens may go out of focus.
	ON	

 : Factory-preset

Menu Screen Available Using The MENU Button (cont.)

TAPE LENGTH	Allows you to set the tape length depending on the tape used (☞ pg. 12).	
REC TIME	Refer to "Animation" and "Time-Lapse" (☞ pg. 25).	
INT. TIME	Refer to "Time-Lapse" (☞ pg. 25).	
TITLE LANG.	Allows you to select the language (ENGLISH, FRENCH, SPANISH or PORTUGUESE) of Instant Titles (☞ pg. 23).	
DATE/TIME	Allows you to set the current date and time (☞ pg. 11).	
JLIP ID NO.	This number is necessary when connecting the camcorder to a device such as a computer using the J terminal (JLIP). The numbers range from 01 to 99. Factory setting is 06.	
DEMO MODE	ON	<p>Demonstrates certain functions such as Fade/Wipe, etc. When "DEMO MODE" is set to "ON" and the Menu Screen is closed, the demonstration starts.</p> <p>Operating the Power Zoom Lever during the demonstration stops the demonstration temporarily. If the Power Zoom Lever is not moved for more than 1 minute after that, the demonstration will resume.</p> <p>NOTE: When a tape whose Erase Protection tab is in the position that allows recording is loaded in the camcorder, demonstration is not available.</p>
	OFF	Automatic demonstration will not take place.

 : Factory-preset

Date/Time Insert

Allows you to display the date and time in the camcorder or on a connected color monitor, as well as to record them manually or automatically.

You should have already performed the Date/Time Setting procedure (☞ pg. 11).

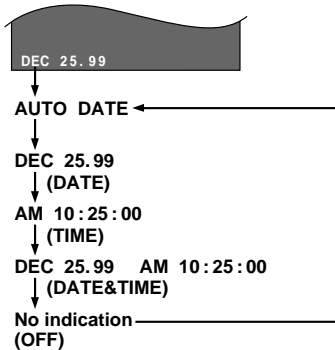
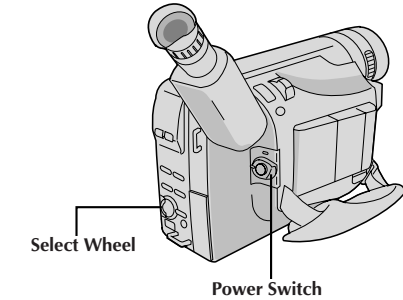

Instant Titles

The camcorder has eight preset titles in memory. You can superimpose one of them over the video image.

Instant Titles can be displayed not only in English but also in French, Spanish and Portuguese. Change the setting in TITLE LANG. in the Menu Screen. (☞ pg. 20, 22).



- 1 Set the Power Switch to "PRO."
- 2 Press the Select Wheel to display the Menu Screen.
- 3 Rotate the Select Wheel to move the highlight bar to "DATE/TIME DISP." while in Record-Standby, then press it to display the Date/Time DISP. Menu.
- 4 Rotate the Select Wheel to move the highlight bar to the desired mode, then press it. The desired mode is activated.
- 5 The Menu Screen reappears with the highlight bar on "RETURN". Press the Select Wheel to close the Menu Screen.

NOTES:

DISPLAY

- The selected display can be recorded.
- If you do not want to record the display, select the OFF mode before shooting.

AUTO DATE

- Your camcorder automatically records the date for about 5 seconds after recording is initiated in the following situations:
 - After changing the date.
 - After loading a cassette.
 - After Auto Date Record mode is selected by rotating the Select Wheel.
- In this mode, the date is replaced after 5 seconds with "AUTO DATE" but this is not recorded.

- 1 Set the Power Switch to "PRO."
- 2 Press the Select Wheel to display the Menu Screen.
- 3 Rotate the Select Wheel to move the highlight bar to "TITLE" while in Record-Standby, then press it to display the TITLE Menu.
- 4 Rotate the Select Wheel to move the highlight bar to the desired mode, then press it. The desired mode is activated.
 - To make the title indication disappear, select "OFF".
- 5 The Menu Screen reappears with the highlight bar on "RETURN". Press the Select Wheel to close the Menu Screen.

NOTE:

The selected title will remain until OFF is selected in the TITLE Menu.

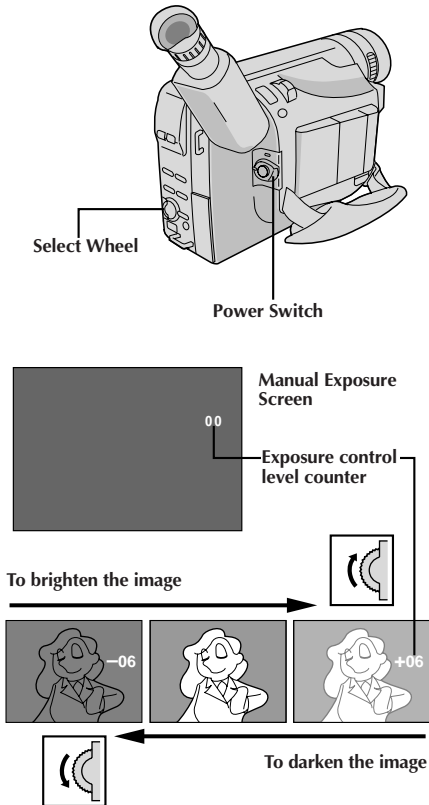

Exposure Control

This feature automatically adjusts the iris for the best available picture quality, but you can override it and make the adjustment manually. Manual exposure adjustment is recommended in the following situations:

- When shooting using reverse lighting or when the background is too bright.
- When shooting on a reflective natural background such as at the beach or when skiing.
- When the background is overly dark or the subject light.

- 1 Set the Power Switch to "PRO."
- 2 Press the Select Wheel to display the Menu Screen.
- 3 Rotate the Select Wheel to move the highlight bar to "EXPOSURE" and press it. The EXPOSURE Menu appears.
- 4 Rotate the Select Wheel to move the highlight bar to "MANU", then press it. The Menu Screen disappears and "00" (exposure control level counter) appears.
- 5 To brighten the image, rotate the Select Wheel upward. The exposure control level counter increases (maximum +06).
To darken the image, rotate the Select Wheel downward. The exposure control level counter decreases (maximum -06).
- 6 Press the Select Wheel. The setting is complete. The Menu Screen reappears with the highlight bar on "RETURN".
- 7 Press the Select Wheel. The Menu Screen disappears and the exposure control level counter reappears to indicate the exposure is adjusted.

NOTES:

- To return to the factory setting, select "AUTO" in step 4.
- To re-adjust exposure, repeat the procedure from step 2.

NOTES:

Before performing the following steps, make sure that:

- The Power Switch is set to "PRO."
- The camcorder is in the Record-Standby mode.
- The recording mode is set to "SP".

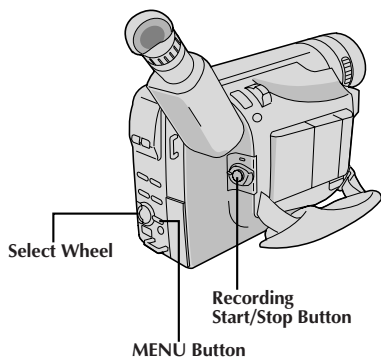
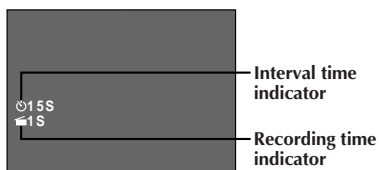
**Display**

INT. TIME and REC TIME indications on the normal screen

Animation

You can shoot a series of pictures, each slightly different, of the same object for a brief period of time.

- 1 Press **MENU**. The Menu Screen appears.
- 2 Rotate the Select Wheel to move the highlight bar to "NEXT" in Menu Screen 1 and press it to display Menu Screen 2. Then, move the highlight bar to "REC TIME" and press it. The REC TIME Menu appears. Rotate the Select Wheel to move the highlight bar to the desired recording time, then press it. The Menu Screen reappears with the highlight bar on "RETURN".
- 3 Press the Select Wheel again to close the Menu Screen.
- 4 Press the Recording Start/Stop Button after focusing on the subject. The recording stops automatically after the selected period of time.
 - Repeat step 4 for the desired number of pictures.
- 5 To release the Animation mode, set "REC TIME" in the Menu screen to "OFF".

Time-Lapse

You can record sequentially at preset time spans. Leaving the camcorder aimed at a specific subject, you can record subtle changes over an extended period of time.

- 1 Set "REC TIME" (☞ step 1 and 2 of "Animation" above).
- 2 Rotate the Select Wheel to move the highlight bar to "INT. TIME" and press it. The INT. TIME Menu appears. Rotate the Select Wheel to move the highlight bar to the desired interval time, then press it. The Menu Screen reappears with the highlight bar on "RETURN". Press the Select Wheel again to close the Menu Screen.
- 3 Press the Recording Start/Stop Button. Recording and intervals alternate automatically.
- 4 To release the Time-Lapse mode, when "REC" is not displayed, press the Recording Start/Stop Button to display "≡PAUSE≡", then set "REC TIME" and "INT. TIME" in the Menu Screen to "OFF".

NOTES (for Animation and Time-Lapse):

- For best results, make sure the camcorder is secured when shooting in Animation or Time-Lapse mode.
- Fade- or wipe-in/out cannot be performed during Animation or Time-Lapse shooting.
- Before performing other operations following Animation or Time-Lapse recording, make sure the Animation or Time-Lapse mode is deactivated.
- Animation and Time-Lapse are canceled when the power is shut off or when the cassette is ejected.

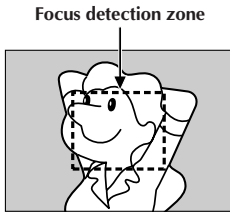
**NOTES:**

- If the lens is smeared or blurred, accurate focusing is not possible. Keep the lens clean, wiping with a piece of soft cloth if it gets dirty. When condensation occurs, wipe with a soft cloth or wait for it to dry naturally.
- When shooting a subject close to the lens, zoom out first (☞ pg. 16). If zoomed in in the auto focus mode, the camcorder could automatically zoom out depending on the distance between the camcorder and the subject. This does not occur with "TELE MACRO" (☞ pg. 21).

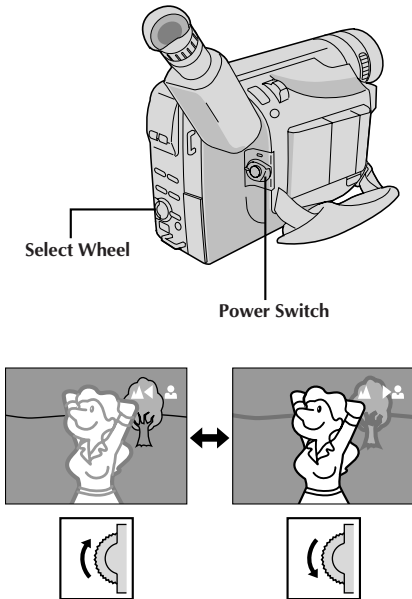
**NOTES:**

- To return to Auto Focus, select "AUTO" in step 4.
- To re-adjust Manual Focus, repeat the procedure from step 2.
- Be sure to focus the lens in the maximum telephoto position when you use the Manual Focus mode. If you focus in on a certain subject in the wide-angle position, sharply focused images cannot be obtained when zoomed in because the depth-of-field is reduced at longer focal lengths.
- When the focus level cannot be adjusted any farther or closer, "▲" or "●" will blink.

Focusing**AUTO FOCUS**

The camcorder's Full Range AF system offers continuous shooting ability from close-up to infinity. However, correct focus may not be obtainable in the situations listed below (in these cases use manual focusing):

- When two subjects overlap in the same scene.
- When illumination is low.*
- When the subject has no contrast (difference in brightness and darkness), such as a flat, one-color wall, or a clear, blue sky.*
- When a dark object is barely visible in the viewfinder.*
- When the scene contains minute patterns or identical patterns that are regularly repeated.
- When the scene is affected by sunbeams or light reflecting off the surface of a body of water.
- When shooting a scene with a high-contrast background.

* The low-contrast warning "▲●" appears

MANUAL FOCUS

If you are using the viewfinder, you should already have made the necessary viewfinder adjustments (☞ pg. 13).

- 1 Set the Power Switch to "PRO."
- 2 Press the Select Wheel to display the Menu Screen.
- 3 Rotate the Select Wheel to move the highlight bar to "FOCUS" and press it. The FOCUS Menu appears.
- 4 Rotate the Select Wheel to move the highlight bar to "MANU", then press it. The Menu Screen disappears and "▲" and "●" appear. The focus is locked at this point.
- 5 To focus on a farther subject, rotate the Select Wheel upward. "◀" appears and blinks.
To focus on a nearer subject, rotate the Select Wheel downward. "▶" appears and blinks.
- 6 Press the Select Wheel. The setting is complete. The Menu Screen reappears with the highlight bar on "RETURN".
- 7 Press the Select Wheel. The Menu Screen disappears and "▲●" reappears to indicate the focus is locked.

White Balance Adjustment

A term that refers to the correctness of color reproduction under various lighting. If the white balance is correct, all other colors will be accurately reproduced.

The white balance is usually adjusted automatically. However, more advanced camcorder operators control this function manually to achieve a more professional color/tint reproduction.

- 1** Set the Power Switch to "PRO".
- 2** Press **MENU**. The Menu Screen appears.
- 3** Rotate the Select Wheel to move the highlight bar to "M.W.B.", then press it. The Menu Screen disappears and the M.W.B. Menu appears.
- 4** Rotate the Select Wheel to move the highlight bar to the desired setting.
 - "**AUTO**"
White balance is adjusted automatically (factory preset).
 - "☀ : **FINE**"
Outdoors on a sunny day.
 - "☁ : **CLOUD**"
Outdoors on a cloudy day.
 - "💡 : **HALOGEN**"
A video light or similar type of lighting is used.
 - "**MWB**"
White balance is set manually.
- 5** Press the Select Wheel. The Menu Screen reappears with the highlight bar on "RETURN". Press the Select Wheel again to close the Menu Screen.

To Return To Automatic White Balance . . .

.... select "AUTO" in step 4. Or set the Power Switch to "AUTO".

NOTE:

White balance cannot be used when Sepia (☞ pg. 19) is activated.

Manual White Balance Operation

Perform Manual White Balance when shooting under various types of lighting.

- 1** Follow steps 1 through 4 of the white balance adjustment, and select "MWB".
- 2** Hold a sheet of plain white paper in front of the subject. Adjust zoom or position yourself so that the white paper fills the screen.
- 3** Press the Select Wheel until "MWB" begins blinking. When the setting is completed, "MWB" stops blinking, and the Menu Screen reappears with the highlight bar on "RETURN".
- 4** Press the Select Wheel again to close the Menu Screen.

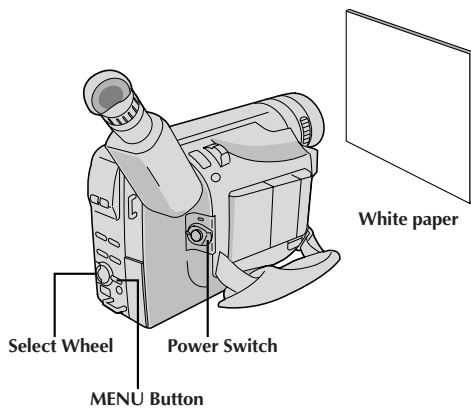

To Change The Tint For Recording . . .

.... in step 2, substitute colored paper for white. The white balance is adjusted based on the color, changing the tint. Red paper = deeper green; blue paper = orange; yellow paper = deeper purple.

NOTES:

- In step 2, it may be difficult to focus on the white paper. In such a case, adjust focus manually (☞ pg. 26).
- A subject can be shot under various types of lighting conditions indoors (natural, fluorescent, candlelight, etc.). Because the color temperature is different depending on the light source, the subject tint will differ depending on the white balance settings. Use this function for a more natural result.
- Once you adjust white balance manually, the setting is retained even if the power is turned off or the battery removed.

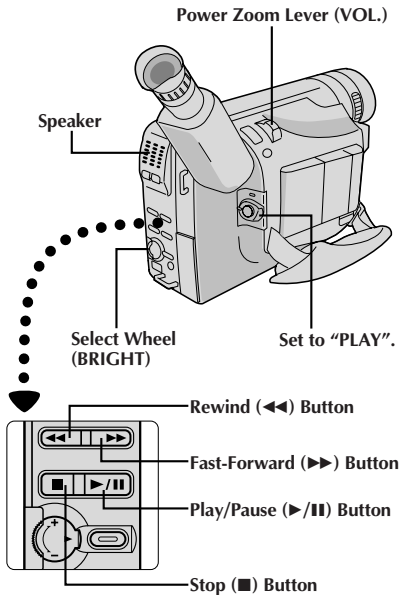

1 Load a tape (☞ pg. 10).

2 Set the Power Switch to "PLAY". To start playback, press ▶/||.

- To stop playback, press ■.
- Press ◀◀ to rewind, or ▶▶ to fast-forward the tape during Stop mode.

NOTES:

- The camcorder shuts off automatically after about 5 minutes in Stop mode. To turn on again, set the Power Switch to "OFF", then to "PLAY".
- When the Power Switch is set to "PLAY" and the LCD monitor is opened at an angle of 60 degrees or more, the LCD monitor switches on and the viewfinder switches off automatically to save power.
- The playback picture can be viewed in the viewfinder (with the LCD monitor shut), on the LCD monitor or on a connected TV (☞ pg. 30, 31).
- You can also view the playback picture on the LCD monitor with it flipped over and retracted.
- If a blank portion on the tape is played back, the screen may become black. This is not a malfunction.

LCD Monitor Brightness Adjustment: Rotate the Select Wheel (BRIGHT) towards "+" to brighten, or towards "-" to darken.

- The Bright Level Indicator is displayed under the Date/Time Display when you play back images recorded in Wide Mode (☞ pg. 21).

Speaker Volume Control: Slide the Power Zoom Lever (VOL.) towards "+" to turn up the volume, or towards "-" to turn down the volume.

- The Speaker Volume Indicator is displayed under the Date/Time Display when you play back images recorded in Wide Mode (☞ pg. 21).

Still Playback: Pauses during playback.

- 1) Press ▶/|| during playback.
 - 2) To resume normal playback, press ▶/|| again.
- Noise bars will appear and the picture will become monochrome during Still Playback.

Shuttle Search: Allows high-speed search in either direction.

- 1) Press ▶▶ for forward or ◀◀ for reverse search during playback.
 - 2) To resume normal playback, press ▶/||.
- During playback, press and hold ◀◀ or ▶▶. The search continues as long as you hold the button. Once you release it, normal playback resumes.
 - Noise bars appear and pictures may become monochrome or darken during Shuttle Search. This is normal.

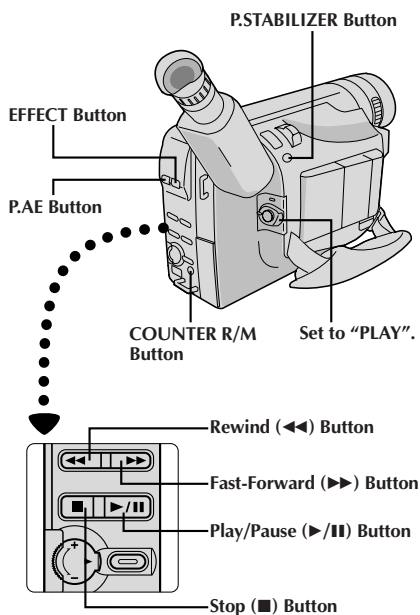

Tracking: Eliminates noise bars that appear on-screen during playback. Factory-preset is Auto Tracking.

To activate Manual Tracking:

- 1) Press **P.AE** and **EFFECT** simultaneously. "MT" appears.
- 2) Press **P.AE** or **EFFECT** as many times as necessary until the noise bars disappear.

- To return to Auto Tracking, press **P.AE** and **EFFECT** simultaneously. "AT" blinks. When Auto Tracking finishes, the indication disappears.
- When noise bars appear during playback, the camcorder enters the Auto Tracking mode and "AT" is displayed.
- Manual Tracking may not work with tapes recorded on other VCRs or camcorders.

TBC (Time Base Corrector): Removes jitter from fluctuating video signals to deliver a stable picture even with old tapes. Factory-preset: TBC is engaged.

To activate/release the TBC mode, press **P.STABILIZER** during playback for more than 1 second. When the TBC mode is activated, "TBC" is displayed.

- The "TBC" indicator turns green (gray with a camcorder equipped with a black/white viewfinder) while TBC is working.
- TBC does not work during still playback and shuttle search.
- The "TBC" indicator turns white while TBC is not operative.
- It may take a few seconds before TBC actually starts working.
- The picture may be distorted if the TBC mode is activated or deactivated at the edit-in/-out points or when normal playback resumes after still playback or shuttle search.
- If the playback picture is distorted when TBC is set to on, turn off TBC.

Counter Memory Function: Makes it easier to locate a specific tape segment.

- 1) Press **COUNTER R/M** and hold for more than 1 second. The counter resets to "0:00:00".
 - 2) Press **COUNTER R/M** for less than 1 second. "M" appears.
 - 3) After recording or playback, press **■**, then **◀◀**. The tape automatically stops at or close to 0:00:00.
 - 4) Press **▶/||** to start playback.
- The counter memory functions in the Fast-Forward and Rewind modes.
 - To disable the Counter Memory Function, press **COUNTER R/M** for less than 1 second so that "M" disappears.

These are some basic types of connections. When making connections, refer also to your VCR and TV instruction manuals.

Basic Connections

Use optional Video and Audio cables.

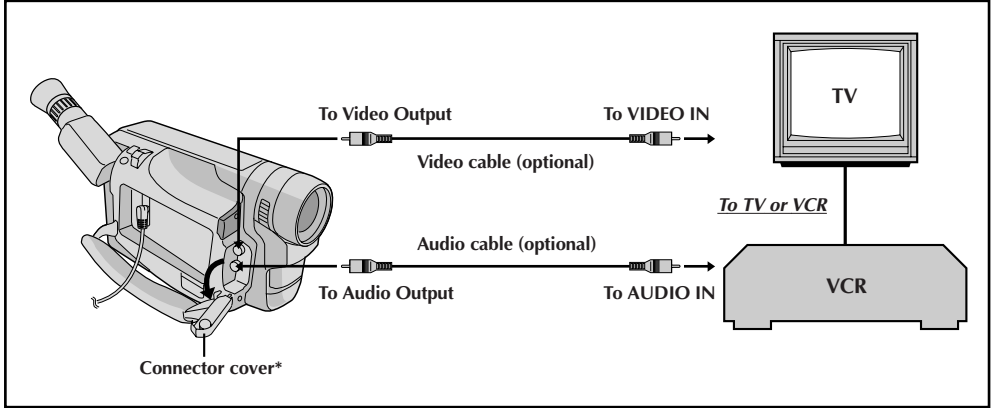

Connection For Tape Dubbing

Use optional Video and Audio cables.

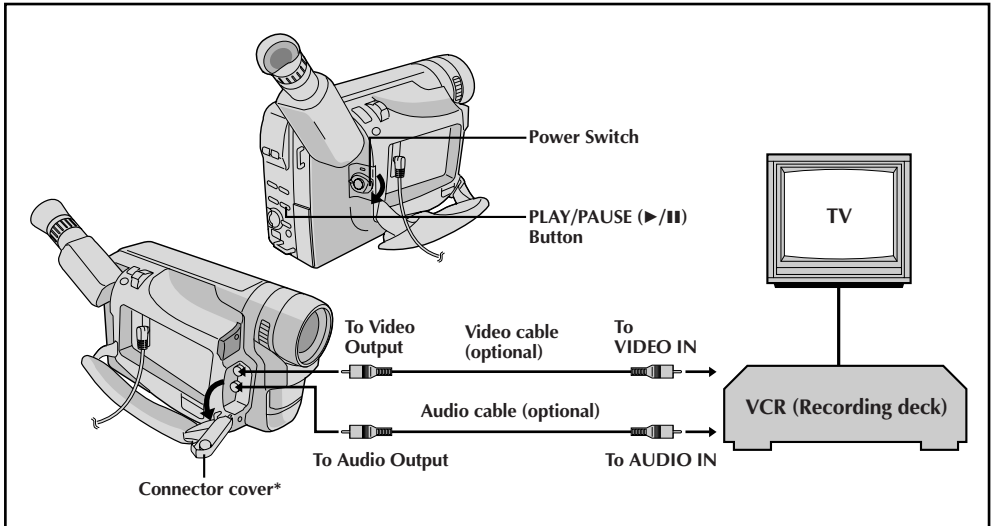

* When connecting the cables, open this cover.

Basic Connections

- 1** Make sure all units are turned off.

- 2** Connect the camcorder to a TV or VCR as shown in the illustration (☞ pg. 30).
If using a VCR . . . go to step 3.
If not . . . go to step 4.

- 3** Connect the VCR output to the TV input, referring to your VCR's instruction manual.

- 4** Turn on the camcorder, the VCR and the TV.

- 5** Set the VCR to its AUX input mode, and set the TV to its VIDEO mode.

NOTES:

- ***It is recommended to use the AC Power Adapter/Charger as the power supply instead of the battery pack (☞ pg. 9).***
- *To monitor the picture and sound from the camcorder without inserting a tape, set the camcorder's Power Switch to "CAMERA" ("AUTO" or "PRO."), then set your TV to the appropriate input mode.*
- *Make sure you adjust the TV sound volume to its minimum level to avoid a sudden burst of sound when the camcorder is turned on.*
- *If you have a TV or speakers that are not specially shielded, do not place the speakers adjacent to the TV as interference will occur in the camcorder playback picture.*

Tape Dubbing

- 1** Following the illustration on pg. 30, connect the camcorder and the VCR.

- 2** Set the camcorder's Power Switch to "PLAY", turn on the VCR's power, and insert the appropriate cassettes in the camcorder and the VCR.

- 3** Engage the VCR's AUX and Record-Pause modes.

- 4** Engage the camcorder's Play mode to find a spot just before the edit-in point. Once it is reached, press ►/|| on the camcorder.

- 5** Press ►/|| on the camcorder and engage the VCR's Record mode.

- 6** Engage the VCR's Record-Pause mode and press ►/|| on the camcorder.

- 7** Repeat steps 4 through 6 for additional editing, then stop the VCR and camcorder when finished.

Cassette Adapter (VHS Playpak)

Use this to play back a VHS-C video cassette recorded with this camcorder on a VHS VCR. It is fully compatible with any VHS video cassette recorder. The C-P7U adapter is battery powered and automatically performs tape loading and unloading.

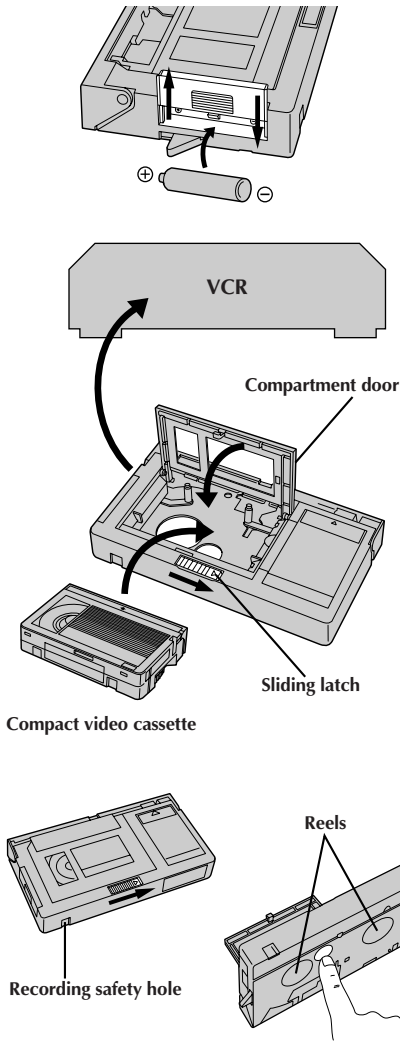

- 1** Slide the battery cover up to remove it, install one "AA (R6)" size battery as shown, then reattach the cover.
- 2** Slide the latch to open the adapter compartment door, then insert the cassette and close the compartment door.
- 3** Load the cassette adapter into the VCR and play the tape back as you would any other.
- 4** Slide the latch and the compartment door opens automatically. This may take around 10 seconds. Do not attempt to force the adapter open. Then, insert your finger in the hole on the underside of the adapter as shown in the illustration at left, and push up and remove the cassette.

NOTES:

- During tape loading and unloading, do not touch the reels for safety and tape protection.
- During special-effect playback (slow motion, still frame, etc.), the picture may vibrate or noise bars may appear on the screen.
- To record on a VCR using a compact cassette and the adapter, cover the adapter's recording safety hole with adhesive tape.

LENS COVER Open/Close Ring

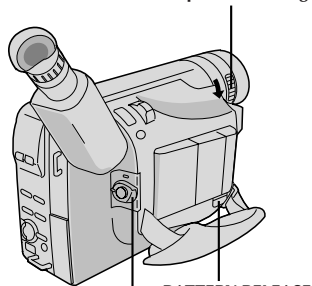

Set to "OFF".

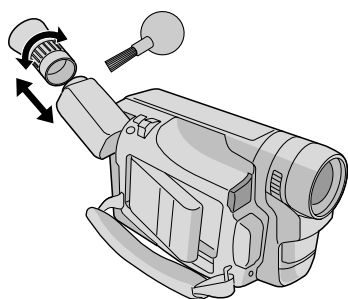
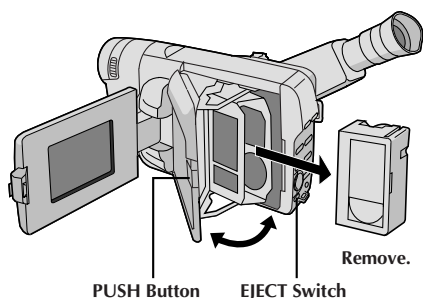

After Use

- 1** Turn off the camcorder.
- 2** Open the LCD monitor fully. Slide **EJECT** to open the cassette holder, then remove the cassette.
- 3** Press **PUSH** to close and lock the cassette holder.
- 4** Close and lock the LCD monitor.
- 5** Slide **BATTERY RELEASE** to remove the battery pack.
- 6** Turn the **LENS COVER Open/Close Ring** to close the lens cover.

Cleaning The Camcorder

- 1** To clean the exterior, wipe gently with a soft cloth. Put the cloth in diluted mild soap and wring it well to wipe off heavy dirt. Then wipe again with a dry cloth.
- 2** Open the LCD monitor and wipe gently with a soft cloth. Be careful not to damage the monitor. Close the LCD monitor.
- 3** To clean the lens, blow it with a blower brush, then wipe gently with lens cleaning paper.
- 4** To detach the eyepiece, turn it counterclockwise and pull it out.
- 5** Remove dust from the viewfinder using a blower brush.
- 6** Re-attach the eyepiece and turn it clockwise.

NOTES:

- Avoid using strong cleaning agents such as benzine or alcohol.
- Cleaning should be done only after the battery pack has been removed or other power units have been disconnected.
- Mold may form if the lens is left dirty.
- When using a cleaner or chemically treated cloth refer to the cautions of each product.
- When removing the eyepiece, be sure to hold the viewfinder securely.

If, after following the steps in the chart below, the problem still exists, please consult your JVC dealer.







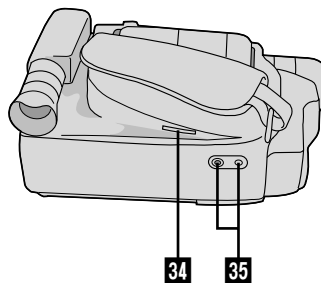
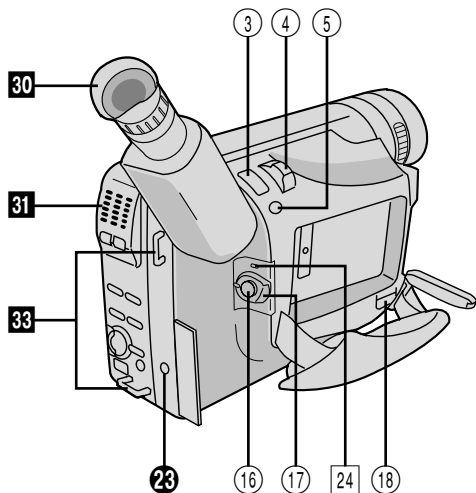
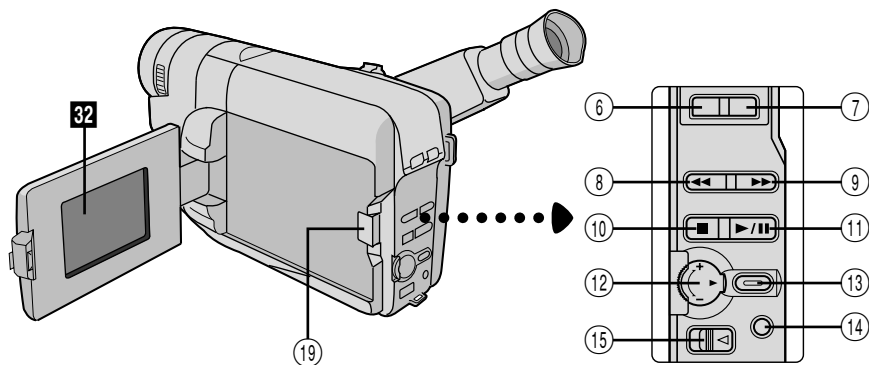
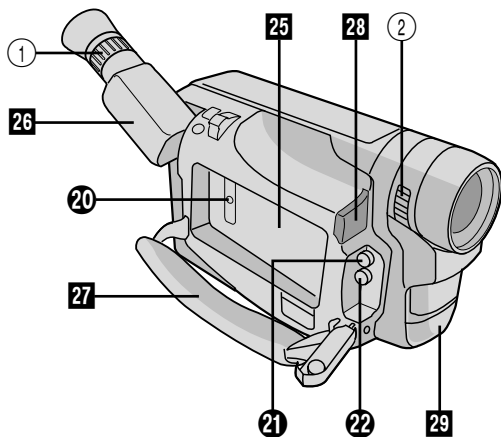





















The camcorder is a microcomputer-controlled device. External noise and interference (from a TV, a radio, etc.) might prevent it from functioning properly. In such cases, first disconnect its power supply unit (battery pack, AC Power Adapter/Battery Charger, etc.) and clock battery; and then re-connect it and proceed as usual from the beginning.

SYMPTOM	POSSIBLE CAUSE(S)
POWER	
No power is supplied.	<ul style="list-style-type: none"> ● The battery pack has not been attached correctly (☞ pg. 8). ● The battery pack is not charged (☞ pg. 8). ● The power supply has not been correctly connected (☞ pg. 9).
The power suddenly goes off and does not come back on by itself.	<ul style="list-style-type: none"> ● The battery pack has completely discharged. ● Remove the cassette and disconnect the power source, then after a few minutes, try turning the power back on. If it still does not come on, consult your nearest JVC dealer.
RECORDING	
Recording cannot be performed.	<ul style="list-style-type: none"> ● Make sure the Erase Protection tab is in the position that allows recording. If not, slide the tab. Some cassettes have removable tabs. If the tab has been removed, cover the hole with adhesive tape (☞ pg. 10).
Recording does not start.	<ul style="list-style-type: none"> ● The camcorder Power Switch has not been set to "CAMERA" ("AUTO" or "PRO.".) (☞ pg. 14).
Animation or Time-Lapse is not available.	<ul style="list-style-type: none"> ● Before recording in the Animation mode at the very beginning of a tape, set the camcorder to the Recording mode for about 5 seconds, so that the tape runs smoothly. Using the Fade-in function at this point is a good way to begin an animated program (☞ pg. 25).
PLAYBACK	
The tape is running, but there is no playback picture.	<ul style="list-style-type: none"> ● The TV has not been set to its VIDEO mode or channel. ● If A/V connection is used, the TV's VIDEO/TV Switch has not been set to VIDEO.
Playback picture is blurred or interrupted.	<ul style="list-style-type: none"> ● The video heads are dirty or worn out. Consult your nearest JVC dealer for head cleaning or replacement.
The counter indication is blurred during Still playback.	<ul style="list-style-type: none"> ● This is normal.
TAPE TRANSPORT	
The tape stops during fast-forward or rewind.	<ul style="list-style-type: none"> ● The Counter Memory Function has been activated (☞ pg. 29).
Rewinding or fast-forwarding cannot be performed.	<ul style="list-style-type: none"> ● The tape is already fully wound on one reel or the other.



SYMPTOM	POSSIBLE CAUSE(S)
OTHER	
During recording, the indications do not appear.	<ul style="list-style-type: none"> ● Press DISPLAY for longer than 1 second to make the indications appear (☞ pg. 15).
The tape will not eject.	<ul style="list-style-type: none"> ● The battery pack is running low. ● If the LCD monitor is not open over 60 degrees, the EJECT Switch does not function.
Some functions are not available.	<ul style="list-style-type: none"> ● The Power Switch is set to "AUTO". ● Certain combinations of modes or effects are not possible to use.
Vertical white lines appear when shooting a very bright object.	<ul style="list-style-type: none"> ● This sometimes occurs when the contrast between the background and the object is great. It is not a defect of the camcorder.
Bright, crystal-shaped spots appear in the LCD monitor and the viewfinder.	<ul style="list-style-type: none"> ● Sunlight is directly entering the lens. This is not a defect of the camcorder.
The rear of the LCD monitor is hot.	<ul style="list-style-type: none"> ● The light used to illuminate the LCD monitor causes it to be hot. Close the LCD monitor to turn it off or set the Power Switch to "OFF", and let the unit cool down.
Colored bright spots appear all over the LCD monitor or the viewfinder.	<ul style="list-style-type: none"> ● The LCD monitor and the viewfinder are made with high-precision technology. However, black spots or bright spots of light (red, green or blue) may appear constantly on the LCD monitor or in the viewfinder. These spots are not recorded on the tape. This is not due to any defect of the unit. (Effective dots: more than 99.99 %.)
The indicators and the picture color on the LCD monitor are not clear.	<ul style="list-style-type: none"> ● This may occur when the surface or the edge of the LCD monitor is pressed.
The LCD monitor, the viewfinder and the lens have become dirty (ex. fingerprints).	<ul style="list-style-type: none"> ● Wipe them gently with a soft cloth. Gently wipe in a semicircular motion, as wiping strongly spreads the stain and it won't come out easily.
The picture is blurred in the Quick Review or Retake mode.	<ul style="list-style-type: none"> ● This is normal while recording in the EP mode. Some noise may be present while recording in the SP mode (☞ pg. 12).
An error number (i.e. E03) appears.	<ul style="list-style-type: none"> ● Turn the camcorder's power off, then disconnect the power source. After a few minutes, try turning the power on again. If the error number still appears in the viewfinder, consult your nearest JVC dealer.
The image is out of focus.	<ul style="list-style-type: none"> ● The diopter needs to be adjusted (☞ pg. 13). ● The scene being shot is adversely affecting the operation of Auto Focus (☞ pg. 26).
The date and time displays disappear.	<ul style="list-style-type: none"> ● If you remove the power source from the camcorder while the power is on, all settings and selections are erased. Make sure to turn the camcorder's power off before disconnecting the power source.
The wrong date and time are displayed/recorded.	<ul style="list-style-type: none"> ● If you have not performed Date/Time Setting (☞ pg. 11), the date and time are not displayed/recorded correctly. Be sure that Date/Time setting is carried out.
Even though the lens cover is open, the Lens Cover Warning indicator blinks.	<ul style="list-style-type: none"> ● The Lens Cover Warning indicator may blink when the camcorder is used in dark areas, regardless of the position of the lens cover.



Controls

- ① Diopter Adjustment Control  pg. 13
- ② Lens Cover Open/Close Ring  pg. 14
- ③ 5-Second Recording Button
[5 SEC. REC]  pg. 17
- ④ • Power Zoom Lever [T/W]  pg. 16
- Speaker Volume Control [VOL.]  pg. 28
- ⑤ • Picture Stabilizer Button
[P.STABILIZER]  pg. 16
- Time Base Corrector Button  pg. 29
- ⑥ Program AE Button [P.AE]  pg. 19
- ⑦ Fade/Wipe Button [EFFECT]  pg. 18
- ⑧ • Retake Rewind Button [RETAKE R]  pg. 17
- Quick Review Button [ R]  pg. 17
- Rewind Button [REW]  pg. 28
- ⑨ • Retake Forward Button [RETAKE F]  pg. 17
- Fast-Forward Button [FF]  pg. 28
- ⑩ Stop Button [STOP]  pg. 28
- ⑪ Play/Pause Button
[PLAY/PAUSE]  pg. 28
- ⑫ • Select Wheel [PUSH]  pg. 20
- Bright Dial [BRIGHT]  pg. 14, 28
- ⑬ MENU/DISPLAY Button  pg. 15, 20
- ⑭ • Recording Mode Button [SP/EP]  pg. 12
- Counter Reset/Memory Button
[COUNTER R/M]  pg. 29
- ⑮ EJECT Switch  pg. 10
- ⑯ Recording Start/Stop Button  pg. 14
- ⑰ Power Switch
[ , OFF, AUTO, PRO.]  pg. 14, 28
- ⑱ Battery Release Switch
[BATTERY RELEASE]  pg. 9
- ⑲ PUSH Button  pg. 10









Connectors

- ⑳ DC IN Connector  pg. 9
- The connectors ㉑ to ㉓ are located beneath the cover.
- ㉑ Video Output Connector  pg. 30
 - ㉒ Audio Output Connector  pg. 30
 - ㉓ J Terminal [JLIP (Joint Level Interface Protocol) Connector]
 - It is used to connect the camcorder to a device such as a personal computer.
For further details consult your nearest JVC dealer.
 - JLIP-controlled editing from camcorder to VCR is not possible if the VCR is not equipped with a J terminal.

Indicators

- ㉔ Power Lamp  pg. 14

Other Parts

- ㉕ Battery Pack Mount  pg. 9
- ㉖ Viewfinder  pg. 13
- ㉗ Grip Strap  pg. 13
- ㉘ Camera sensor
Be careful not to cover this area; a sensor necessary for shooting is built-in here.
- ㉙ Microphone
For use when recording.
- ㉚ Eyepiece  pg. 33
- ㉛ Speaker  pg. 28
- ㉜ LCD Monitor  pg. 15
- ㉝ Shoulder Strap Eyelets  pg. 13
- ㉞ Clock Battery Slot  pg. 10
- ㉟ Tripod Mounting Socket  pg. 13

Indications During Recording

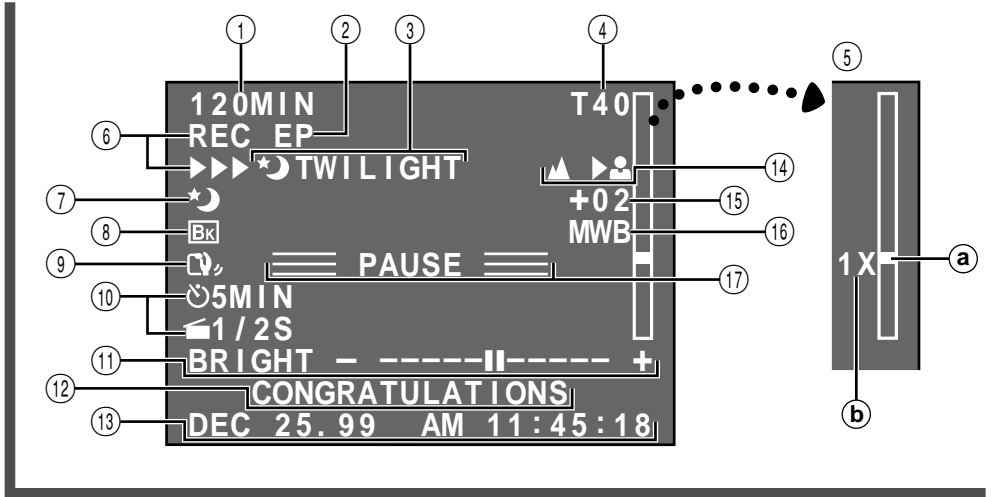

- ① Tape Remaining Time pg. 15
Blinks when a tape is about to reach its end.
- ② Recording Mode Indicator (SP/EP) pg. 12
- ③, ⑦ Program AE Indicator pg. 19
Displayed at ③ for approx. 2 seconds when Program AE with special effects is switched from one mode to another by pressing **P.AE.**, then only the indicator remains at ⑦.
- ③, ⑧ Fade/Wipe-Standby Indicator pg. 18
Displayed at ③ for approx. 2 seconds when the Fade/Wipe is switched from one effect to another by pressing **EFFECT**, then only the indicator remains at ⑧.
- ④ Tape Length Indicator pg. 12
- ⑤ Zoom Indicator Bar pg. 16
- a Zoom Level Indicator
- b Approximate Zoom Ratio
- ⑥ Recording Indicator pg. 14
- ⑨ Picture Stabilizer Indicator pg. 16
- ⑩ • Interval Timer/Recording Time Indicator pg. 25
 • 5 Sec. Rec Mode Indicator pg. 17
- ⑪ Bright Level Indicator pg. 14
- ⑫ Instant Title Display pg. 23
- ⑬ Date/Time Display pg. 23
- ⑭ Focus Indicator pg. 26
- ⑮ Exposure Control Level Counter pg. 24
- ⑯ White Balance Mode Indicator pg. 27
- ⑰ Record-Standby Mode Indicator pg. 14

Indications During Playback

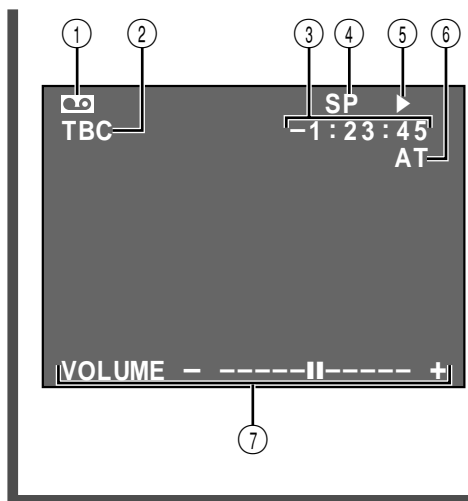

- ① Cassette Indicator
Displayed when a tape is loaded.
- ② TBC Indicator pg. 29
- ③ Tape Counter pg. 29
- ④ Recording Mode Indicator (SP/EP) pg. 12
- ⑤ Tape Running Indicator
 - ▶ : Playback
 - ▶▶ : Fast-Forward/Shuttle Search
 - ◀◀ : Rewind/Shuttle Search
 - || : Pause
- ⑥ Tracking Indicator pg. 29
- ⑦ • BRIGHT: Bright Level Indicator pg. 28
- VOLUME: Speaker Volume Indicator pg. 28

Warning Indications

Indications	Function
	<p>Displays the battery remaining power.</p> <p>Remaining power level: high. It does not necessarily mean that the battery pack is fully charged. </p> <p>Remaining power level: exhausted </p> <p>As the battery power comes close to nil, the battery indicator blinks (battery power warning). When the battery power is exhausted, power turns off automatically.</p>
	<p>Blinks when no cassette is loaded, or when the Erase Protection tab is not in the position that allows recording. pg. 10</p>
	<p>Blinks for approx. 10 seconds when the power is turned on. This display also blinks when the clock (lithium) battery is either not installed or has discharged. Install or replace the old battery with a new one. pg. 10</p>
TAPE END	<p>Appears when the tape ends during recording, playback or fast-forward. pg. 15</p>
LENS COVER	<p>Blinks for approx. 5 seconds when the camcorder is turned on with the lens cover closed. pg. 14</p>
 CONDENSATION OPERATION PAUSED PLEASE WAIT	<p>These 2 warnings appear alternately every 3 seconds if condensation occurs. In this case, all functions except tape eject and power on/off are disabled. Turn the unit off (without removing the power supply), wait a few minutes for the warnings to clear, and turn it on again.</p>
 HEAD CLEANING REQUIRED USE CLEANING CASSETTE	<p>These 2 warnings appear alternately every 3 seconds if dirt is detected on the heads during recording. In this case, use an optional cleaning cassette. If the warning remains after cleaning, consult your nearest JVC dealer.</p>
E01—E06 UNIT IN SAFEGUARD MODE REMOVE AND REATTACH BATTERY	<p>The error indications (E01 — E06) show what type of malfunction has occurred. If an error indication and warning appear, turn the unit off, remove the power supply (battery, etc.) and wait a few minutes for them to clear. When it does, you can resume using the camcorder. If the indication remains, consult your nearest JVC dealer.</p>

When using the AC Power Adapter/Charger in areas other than the USA

- The provided AC Power Adapter/Charger features automatic voltage selection in the AC range from 110 V to 240 V.

USING HOUSEHOLD AC PLUG ADAPTER

In case of connecting the unit's power cord to an AC wall outlet other than American National Standard C73 series type use an AC plug adapter, called a "Siemens Plug", as shown.

For this AC plug adapter, consult your nearest JVC dealer.

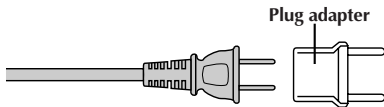

General Battery Precautions

- When the C-P6U or C-P7U (cassette adapter) is not functioning even when correctly operated, the battery is exhausted. Replace it with a fresh one.
- Use only the following battery:
C-P6U or C-P7U AA (R6) size

Please make note of the following rules for battery use. When misused, the battery can leak or explode.

1. Refer to the C-P6U/C-P7U instructions when replacing the battery.
2. **Do not** expose the battery to excessive heat as it can leak or explode.
3. **Do not** dispose of the battery in a fire.
4. Remove the battery from the unit if it is to be stored for an extended period to avoid battery leakage which can cause malfunctions.

Battery Packs

The battery packs are nickel-cadmium or nickel metal-hydrate batteries. Before using the supplied battery pack or an optional battery pack, be sure to read the following cautions:

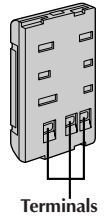

1. **To avoid hazard . . .**
 - ... **do not** burn.
 - ... **do not** short-circuit the terminals.
 - ... **do not** modify or disassemble.
 - ... use only specified chargers.
2. **To prevent damage and prolong service life . . .**
 - ... **do not** subject to unnecessary shock.
 - ... avoid repeated charging without fully discharging.
 - ... charge in an environment where temperatures are within the tolerances shown in the chart below. This is a chemical reaction type battery—cooler temperatures impede chemical reaction, while warmer temperatures can prevent complete charging.
 - ... store in a cool, dry place. Extended exposure to high temperatures will increase natural discharge and shorten service life.
 - ... avoid prolonged uncharged storage.
 - ... remove from charger or powered unit when not in use, as some machines use current even when switched off.

NOTES:

- *It is normal for the battery pack to be warm after charging, or after use.*
Temperature Range Specifications
Charging 10°C to 35°C (50°F to 95°F)
Operation 0°C to 40°C (32°F to 104°F)
Storage -10°C to 30°C (14°F to 86°F)
- *Recharging time is based on room temperature of 20°C (68°F).*
- *The lower the temperature, the longer recharging takes.*

Cassettes

To properly use and store your cassettes, be sure to read the following cautions:

1. During use . . .

- ... make sure the cassette bears the VHS-C mark.
- ... be aware that recording onto prerecorded tapes automatically erases the previously recorded video and audio signals.
- ... make sure the cassette is positioned properly when inserting.
- ... do not load and unload the cassette repeatedly without allowing the tape to run at all. This slackens the tape and can result in damage.
- ... do not open the front tape cover. This exposes the tape to fingerprints and dust.

2. Store cassettes . . .

- ... away from heaters or other heat sources.
- ... out of direct sunlight.
- ... where they won't be subject to unnecessary shock or vibration.
- ... where they won't be exposed to strong magnetic fields (such as those generated by motors, transformers or magnets).
- ... vertically, in their original cases.

Main Unit

1. For safety, DO NOT . . .

- ... open the camcorder's chassis.
- ... disassemble or modify the unit.
- ... short-circuit the terminals of the battery pack. Keep it away from metallic objects when not in use.
- ... allow inflammables, water or metallic objects to enter the unit.
- ... remove the battery pack or disconnect the power supply while the power is on.
- ... leave the battery pack attached when the camcorder is not in use.

2. Avoid using the unit . . .

- ... in places subject to excessive humidity or dust.
- ... in places subject to soot or steam such as near a cooking stove.
- ... in places subject to excessive shock or vibration.
- ... near a television set.
- ... near appliances generating strong magnetic or electric fields (speakers, broadcasting antennas, etc.).
- ... in places subject to extremely high (over 40°C or 104°F) or extremely low (under 0°C or 32°F) temperatures.

3. DO NOT leave the unit . . .

- ... in places of over 50°C (122°F).
- ... in places where humidity is extremely low. (below 35%) or extremely high (above 80%).
- ... in direct sunlight.
- ... in a closed car in summer.
- ... near a heater.

4. To protect the unit, DO NOT . . .

- ... allow it to become wet.
- ... drop the unit or strike it against hard objects.
- ... subject it to shock or excessive vibration during transportation.
- ... keep the lens directed at extremely bright objects for long periods.
- ... direct the eyepiece of the viewfinder at the sun.
- ... carry it by holding the viewfinder or the LCD monitor. Be sure to hold the main unit with both hands or use the grip.
- ... swing it excessively when using the shoulder strap.

LCD Monitor

1. To prevent damage to the LCD monitor, DO NOT . . .

- ... push it strongly or apply any shocks.
- ... place the camcorder with the LCD monitor on the bottom.

2. To prolong service life . . .

- ... avoid rubbing it with coarse cloth.

3. Be aware of the following phenomena for LCD monitor use. These are not malfunctions:

- While using the camcorder, the surface around the LCD monitor and/or the back of the LCD monitor may heat up.
- If you leave power on for a long time, the surface around the LCD monitor becomes hot.

About moisture condensation . . .

- You may have observed that pouring a cold liquid into a glass will cause drops of water to form on the glass' outer surface. This same phenomenon occurs on the head drum of a camcorder when it is moved from a cool place to a warm place, after heating a cold room, under extremely humid conditions or in a place directly subjected to the cool air from an air conditioner.
- Moisture on the head drum can cause severe damage to the video tape, and can lead to internal damage to the camcorder itself.

Serious malfunctioning

If malfunctioning occurs, stop using the unit immediately and consult your local JVC dealer.

A

AC Power Adapter/Charger	pg. 8, 9
Animation Recording	pg. 25
Auto Date Record	pg. 23
Auto Focus	pg. 26
Auto Shut Off	pg. 15, 28

B

Battery Pack	pg. 8, 9, 40
Brighten The Image	pg. 24
Brighten The LCD Monitor	pg. 14

C

Car Battery	pg. 9
Cassette Adapter	pg. 32
Charge Marker	pg. 8
Charging The Battery Pack	pg. 8
Clean The Camcorder	pg. 33
Clock (Lithium) Battery	pg. 10
Connection To A VCR/TV	pg. 30
Contents	cover page
Counter Memory	pg. 29

D

Darken The Image	pg. 24
Darken The LCD Monitor	pg. 14
Date/Time Display	pg. 23
Date/Time Settings	pg. 11
Demonstration Mode	pg. 7, 22
Digital Zoom	pg. 21
Dioptr Adjustment	pg. 13

E

Electronic Fog Filter Mode	pg. 19
Erase Protection	pg. 10
Exposure Control	pg. 24

F

Fade-In/Out	pg. 18
Fast-Forward Tape	pg. 28
5 Sec. Recording	pg. 17

G

Grip Adjustment	pg. 13
-----------------------	--------

H

High Speed Shutter Mode	pg. 19
-------------------------------	--------

I

Instant Titles	pg. 23
Interface Shooting	pg. 15

J

JLIP ID NO.	pg. 22
Journalistic Shooting	pg. 15

L

LCD monitor/Viewfinder, Indications	pg. 38, 39
Load A Tape	pg. 10

M

Manual Focus	pg. 26
Menu Screen	pg. 20 – 22

N

ND Effect Mode	pg. 19
Nega/Posi Mode	pg. 19

P

Picture Stabilizer	pg. 16
Power Switch Position	pg. 14
Program AE With Special Effects	pg. 19
Provided Accessories	pg. 7

Q

Quick Review	pg. 17
--------------------	--------

R

Recording Mode	pg. 12
Record-Standby	pg. 14
Retake	pg. 17
Rewind The Tape	pg. 28

S

Self-Recording	pg. 15
Sepia Mode	pg. 19
Shoulder Strap Attachment	pg. 13
Shuttle Search	pg. 28
Specifications	pg. 43
Sports Mode	pg. 19
Still Playback	pg. 28
Super LoLux (S.LX)	pg. 21

T

Tape Counter	pg. 29
Tape Dubbing	pg. 30, 31
Tape Length Setting	pg. 12
Tele Macro	pg. 21
Time Base Corrector	pg. 29
Time-Lapse Shooting	pg. 25
Tracking	pg. 29
Tripod Mounting	pg. 13
Twilight Mode	pg. 19

U

Unload A Tape	pg. 10
---------------------	--------

V

Viewfinder Adjustment	pg. 13
-----------------------------	--------

W



White Balance Adjustment	pg. 27
Wide Mode	pg. 21
Wipe-In/Out	pg. 18

Z

Zooming	pg. 16
---------------	--------

Camcorder



General

Format	: VHS NTSC standard
Power source	: DC 6.0 V 
Power consumption	
LCD monitor off, viewfinder on	: 4.2 W
LCD monitor on, viewfinder off	: 4.6 W
LCD monitor on, viewfinder on	: 5.2 W
Signal system	: NTSC-type
Video recording system	
Luminance	: FM recording
Color	: Converted sub-carrier direct recording Conforms to VHS standard
Cassette	:  cassette
Tape speed	
SP	: 33.35 mm/sec. (1-5/16 ips)
EP	: 11.12 mm/sec. (7/16 ips)
Recording time (max.)	
SP	: 40 minutes
EP	: 120 minutes (with TC-40)
Operating temperature	: 0°C to 40°C (32°F to 104°F)
Operating humidity	: 35% to 80%
Storage temperature	: -20°C to 50°C (-4°F to 122°F)
Weight	: Approx. 890 g (2.0 lbs)
Dimensions (W x H x D)	: 198 mm x 119 mm x 99 mm (7-13/16" x 4-11/16" x 3-15/16") (with the LCD monitor closed and with the viewfinder fully tilted downward)
Pickup	: 1/4" format CCD
Lens	: F1.6, f = 3.9 to 62.4 mm, 16:1 power zoom lens with auto iris and macro control, filter diameter 40.5 mm
Viewfinder	: Electronic viewfinder with 0.5" black/white CRT
White balance adjustment	: Auto/Manual adjustment
LCD monitor	: 2.5" diagonally measured, LCD panel/TFT active matrix system
Speaker	: Monaural

Connectors

JLIP	: ø3.5 mm, 4-pole, mini-head jack (compatible with RC-5325 plug)
Video	: 1 V (p-p), 75 Ω unbalanced, analog output (via Video output connector)
Audio	: 300 mV (rms), 1 kΩ analog output (via Audio output connector)

AC Power Adapter/Charger AA-V16U

Power requirement	: AC 110 V to 240 V~, 50 Hz/60 Hz
Power consumption	: 23 W
Output	
Charge	: DC 8.5 V  , 1.3 A
VTR	: DC 6.3 V  , 1.8 A
Charging system	: Constant current, peak detection, timer controlled
Dimensions (W x H x D)	: 125 mm x 42 mm x 68 mm (4-15/16" x 1-11/16" x 2-11/16")
Weight	: Approx. 270 g (0.6 lbs)

Cassette Adapter C-P7U

Dimensions (W x H x D)	: 188 mm x 25 mm x 104 mm (7-7/16" x 1" x 4-1/8")
Weight	: Approx. 240 g (0.53 lbs)
Accessory	: "AA (R6)"-size battery x 1

Optional Accessories

- **Battery Packs** BN-V12U, BN-V20U, BN-V856U
- **Car Battery Charger** BH-V3U
- **Battery Charger** BH-VC10U
- **Audio/Video Cable**
- **Car Battery Cord** AP-V7U
- **Compact VHS () Cassettes** TC-40/30/20
- **Active Carrying Bag** CB-V7U

Some accessories are not available in some areas. Please consult your nearest JVC dealer for details on accessories and their availability.

